



ORAC[®]
D E C O R

WALLS

the ABC
of wall
decoration



ORAC[®]
D E C O R



GIVE WALLS
PERSONALITY

en —

Walls have power. They can be invisible, but they can be so much more. Walls tie a room together or divide it. They determine the mood of a space, whether serenity, grandeur, homeliness or festivity.

We believe walls are the most important element of an interior. And that's why we're so passionate about them. Orac Decor® builds on 50 years of history, innovation and quality to revive heritage and create the walls of the future. Let us share our passion with you.

nl —

Muren zijn machtig. Ze kunnen onzichtbaar zijn, maar ook zoveel meer. Muren kunnen een ruimte samenbrengen of ze verdelen. Ze kunnen de uitstraling van een ruimte bepalen, van sereniteit of grandeur tot gezelligheid of uitbundigheid.

Voor ons zijn de muren het element bij uitstek van een interieur. Vandaar dat we er zo gepassioneerd mee begaan zijn. Orac Decor® bouwt op 50 jaar geschiedenis, innovatie en kwaliteit om tradities heruit te vinden en om de muren van de toekomst te creëren. We delen graag onze passie met jou.

fr —

Les murs ont de l'énergie. Ils peuvent être invisibles, mais ils peuvent être bien plus. Les murs peuvent relier une pièce ou la diviser. Ils peuvent déterminer l'ambiance d'un espace, qu'il s'agisse de sérénité, de grandeur, de convivialité ou de festivité.

Nous pensons que les murs sont l'élément le plus important d'un intérieur. C'est pourquoi ils nous passionnent. Orac Decor® s'appuie sur 50 ans d'histoire, d'innovation et de qualité pour revitaliser l'héritage ancien et créer les murs de l'avenir. Laissez-nous partager notre passion avec vous.

de —

Wände haben Macht. Sie können unauffällig sein, aber auch noch so viel mehr. Wände können einen Raum optisch zusammenhalten oder ihn unterteilen. Ob ruhig, prunkvoll, gemütlich oder festlich: Wände können die Stimmung eines Raumes prägen.

Wir glauben, dass Wände das wichtigste Element eines Innenraums sind. Deshalb lassen wir uns jeden Tag aufs Neue von Wänden begeistern. Orac Decor® baut auf 50 Jahre Unternehmensgeschichte, Innovation und Qualität auf, um Traditionelles wiederzubeleben und die Wände der Zukunft zu schaffen. Lassen Sie sich von unserer Begeisterung anstecken.

es —

Las paredes tienen un poder enorme. Para algunos son invisibles, pero para nosotros son mucho más. Las paredes pueden unir una habitación o dividirla. Pueden determinar el estado de ánimo de un espacio. Tienen el poder de convertirlo en un rincón sereno, un hogar, algo especial o el escenario de una celebración.

Creemos que las paredes son el elemento más importante de un interior. Y por eso nos apasionan tanto. Orac Decor® tiene a sus espaldas más de 50 años de historia, innovación y calidad para revivir el legado antiguo y crear las paredes del futuro. ¡Apasíonate por este mundo!

Content

nl —

- 06 The wall says it all
- 20 Hal
- 24 Woonkamer
- 32 Keuken
- 38 Slaapkamer
- 44 Badkamer
- 50 Bar | Resto | Hotel

- 58 Materialen
- 60 Productoverzicht
- 62 Kroonlijsten
- 88 Plinten
- 104 Wandlijsten
- 116 3D Wandbekleding
- 130 Indirecte Verlichting
- 144 Decoratieve Elementen
- 154 De Perfecte Afwerking
- 156 Flexibele Producten

de —

- 06 The wall says it all
- 20 Eingangsbereiche
- 24 Wohnzimmer
- 32 Küche
- 38 Schlafzimmer
- 44 Badezimmer
- 50 Bar | Restaurant | Hotel

- 58 Materialien
- 60 Produktübersicht
- 62 Stuckleisten
- 88 Sockelleisten
- 104 Wand- und Friesleisten
- 116 3D Wandvertäfelung
- 130 Indirekte Beleuchtung
- 144 Zierelemente
- 154 Die perfekte Installation
- 156 Biegbare Produkte

4



5

Content

en —

- 06 The wall says it all
- 20 Hall
- 24 Living room
- 32 Kitchen
- 38 Bedroom
- 44 Bathroom
- 50 Bar | Restaurant | Hotel

- 58 Materials
- 60 Product Overview
- 62 Cornices
- 88 Skirting Boards
- 104 Panel Mouldings
- 116 3D Wall Covering
- 130 Led Coving
- 144 Deco Elements
- 154 The Perfect Finish
- 156 Flexible products

fr —

- 06 The wall says it all
- 20 Hall
- 24 Séjour
- 32 Cuisine
- 38 Chambre à coucher
- 44 Salle de bains
- 50 Bar | Resto | Hotel

- 58 Matériaux
- 60 Aperçu Produits
- 62 Corniches
- 88 Plinthes
- 104 Cimaises
- 116 Revêtements muraux 3D
- 130 Eclairage Indirect
- 144 Eléments Décoratifs
- 154 La Finition Parfaite
- 156 Produits Flexibles

es —

- 06 The wall says it all
- 20 Corredor
- 24 Sala de estar
- 32 Cocina
- 38 Dormitorio
- 44 Baño
- 50 Bar | Restaurante | Hotel

- 58 Materiales
- 60 Resumen de Productos
- 62 Cornisas
- 88 Zócalos
- 104 Molduras
- 116 Revestimiento de pared 3D
- 130 Iluminación Indirecta
- 144 Elementos de Decoración
- 154 El Acabado Perfecto
- 156 Productos Flexibles

The wall says it all

nl —

Ontdek ons House of Personality. Laat je creativiteit de vrije loop terwijl je van de slaapkamer naar de badkamer gaat en van de keuken naar de woonkamer. Beeld je in dat je de wanden aankleedt met jouw persoonlijkheid. Wat inspireert jou vandaag?

fr —

Explorez notre maison des personnalités. Laissez libre cours à votre créativité lorsque vous passez de la chambre à coucher à la salle de bains et de la cuisine au salon. Imaginez que vous projetez votre personnalité sur les murs. Qu'est-ce qui vous inspirera aujourd'hui ?

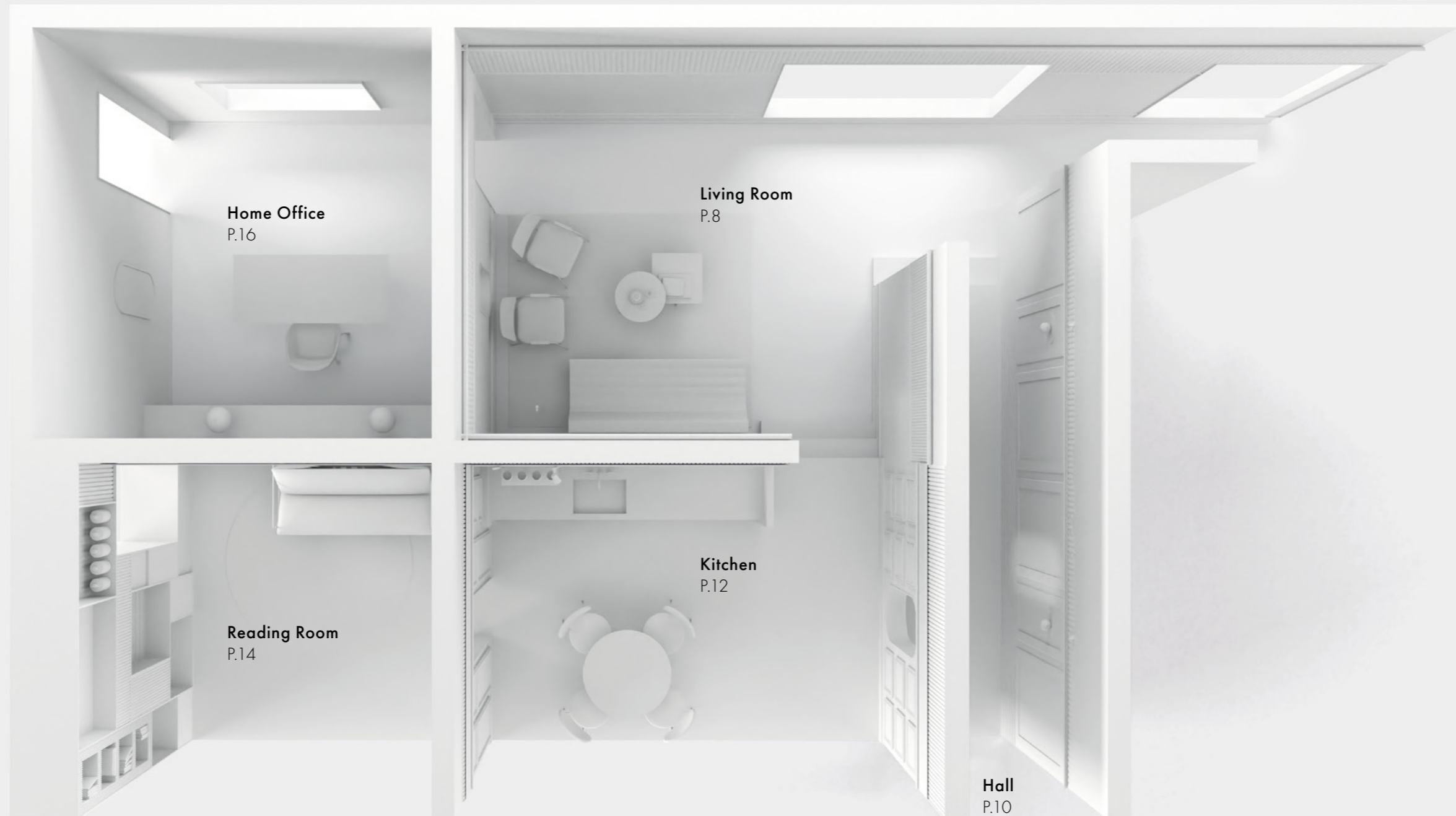

6

7

House of Personality

Explore our House of Personality.

Let your creativity take over as you move from bedroom to bathroom and from kitchen to living room. Imagine injecting your personality on the walls. What will inspire you today?

de —

Entdecken Sie unser Haus der Persönlichkeit. Lassen Sie Ihrer Kreativität freien Lauf, wenn Sie vom Schlafzimmer ins Bad und von der Küche ins Wohnzimmer spazieren. Stellen Sie sich vor, dass Sie den Wänden Ihre Persönlichkeit verleihen. Was inspiriert Sie heute?

es —

Descubre y déjate seducir por House of Personality. Dale rienda suelta a tu creatividad mientras recorres las secciones dedicadas a dormitorios, cuartos de baño, cocinas y salones que tenemos preparadas para ti. ¿Te imaginas poder reflejar tu personalidad en las paredes de tu vivienda? ¿Con qué te seduciremos hoy?

Discover our
House of
Personality



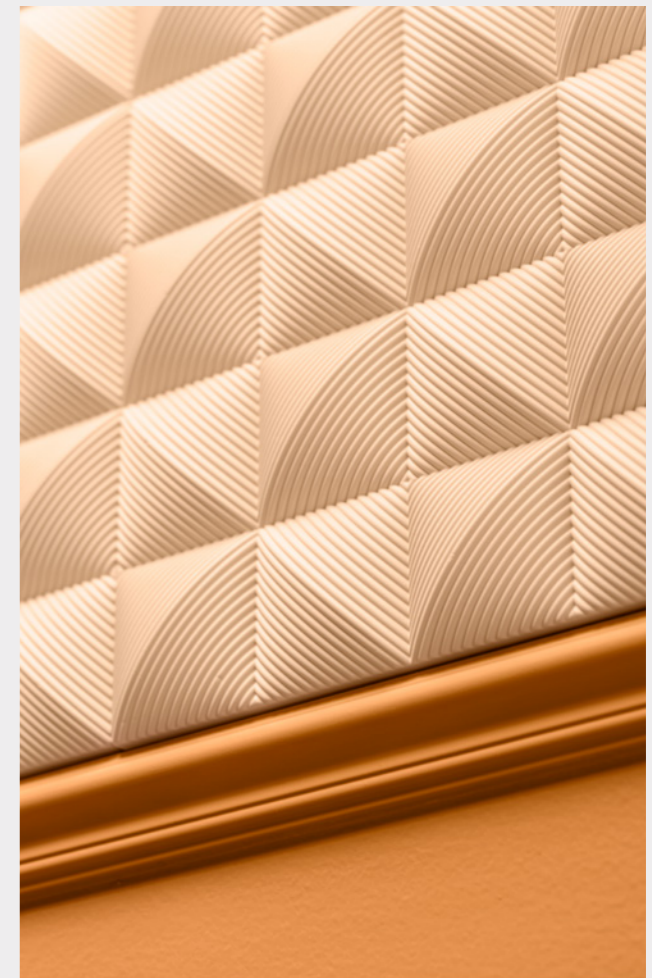

Wall structure and surface textures are combined to create this **relaxing living room**.



nl —
Gestructureerde wanden en textuurvlakken worden gecombineerd in deze gezellige leefruimte.

fr —
La structure du mur et les textures de surface sont combinées pour créer ce salon relaxant.

de —
In diesem Wohnzimmer werden Wandstruktur und Oberflächentextur miteinander kombiniert, um eine entspannte Atmosphäre zu schaffen.

es —
La estructura de la pared y las texturas de la superficie se combinan para crear este relajante salón.



Strong patterns
and graphic lines
transform a dull
passage into an
eye-catching
entrance.



nl —

Krachtige patronen en grafische lijnen toveren een donkere, saaie ruimte meteen om tot een oogverblindende hal.

fr —

Des motifs et des lignes graphiques puissants transforment immédiatement un espace sombre et ennuyeux en couloir attirant.

de —

Markante Muster und grafische Linien verwandeln einen dunklen und langweiligen Raum sofort in einen Flur, der sofort zu einem Blickfang wird.

es —

Patrones y líneas gráficas potentes capaces de transformar en cuestión de segundos un espacio oscuro y aburrido en un atractivo pasillo.



Unconventional combinations in our cosmopolitan kitchen bring daily inspiration.

nl —
De buitengewone combinaties in onze wereldse keuken inspireren elke dag.

fr —
Les combinaisons non conventionnelles dans notre cuisine cosmopolite sont une source d'inspiration quotidienne.

de —
Die unkonventionellen Kombinationen in unserer kosmopolitischen Küche inspirieren uns jeden Tag aufs Neue.

es —
Las combinaciones poco convencionales de nuestra cocina cosmopolita son una fuente diaria de inspiración.



12

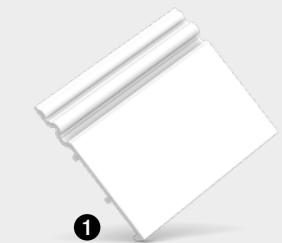

13

Kitchen



1. W110 p.118 | 2. W108 p.118 | 3. W112 p.122 | 4.W130 p.120 | 5. W109 p.118 | 6. W111 p.118 | 7. W113 p.122 | 8. CX190 p.98

Linear, curved or ornamented. The variety of shapes in this **eclectic reading room** energise me to express myself.

nl —

Rechtlijnig, gebogen of geornamenteerd. De vormen in deze eclectische leesruimte geven me energie om mezelf uit te drukken.

de —

Geradlijnig, geschwungen oder ornamentiert. Die Formen in diesem vielseitigen Lesezimmer regen mich dazu an, meine Persönlichkeit auszudrücken.

fr —

Linéaire, courbée ou décorée. Les formes de cette salle de lecture éclectique me donnent énergie et créativité.

es —

Lineal, curvada u ornamentada. Las formas de esta sala de lectura ecléctica animan a la expresión.

Welcome to my urban business environment where linear repetition creates a structured and organized finish.



16



1. SX157 p.102 | 2. W112 p.122 | 3. SX194 p.113

17

Home office

nl —

Welkom in mijn stadse zakenpaleis waar subtiële rechtlijnige herhalingen een gestructureerd en georganiseerd resultaat geven.

fr —

Bienvenue dans mon palais des affaires urbaines où des répétitions linéaires subtiles créent un résultat structuré et organisé.

de —

Willkommen in meinem urbanen Arbeitspalast, in dem die dezente Wiederholung der Linienführungen für einen strukturierten Gesamteindruck sorgt.

es —

Bienvenido a nuestro palacio empresarial urbano, un espacio donde las sutiles repeticiones lineales logran un resultado estructurado y organizado.

For the love of walls

Inspiring projects bursting with personality

nl —

Uit liefde voor muren –
Inspirerende projecten vol
persoonlijkheid.

fr —

Pour l'amour des murs – Des
projets inspirants pleins de
personnalité.

de —

Aus Liebe zu Wänden –
inspirierende Projekte mit
Persönlichkeit.

es —

Auténtica pasión por las paredes
– Proyectos inspiradores llenos
de personalidad.

18



Hall



Living Room

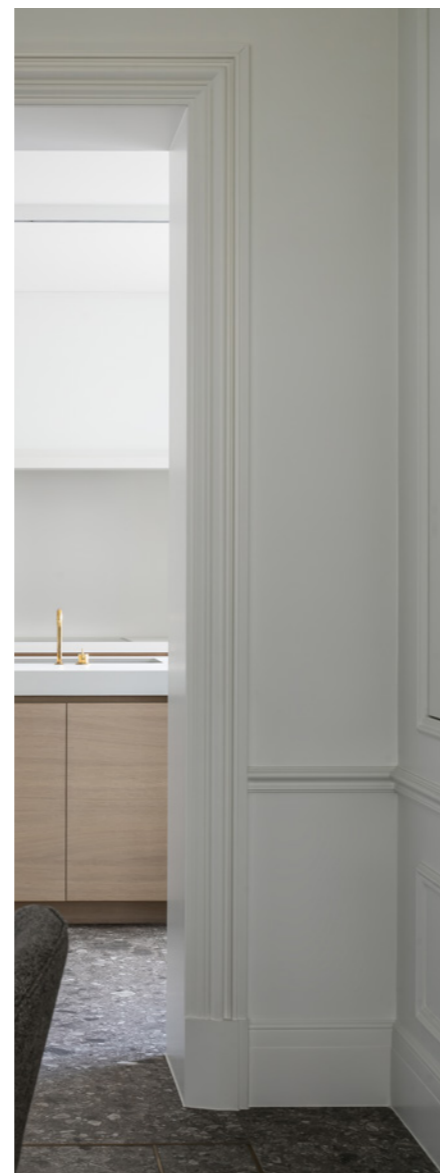

Kitchen



Bathroom



Bedroom



Bar | Resto | Hotel

19

Projects overview

Walls should inspire us,



1. SX163 p.102 | 2. C396 p.77

not limit us



3. C304 | C304F p.71

20

21
Hall projects

nl —
Muren moeten ons inspireren,
niet limiteren.

fr —
Les murs devraient nous inspirer
et non nous limiter.

de —
Wände sollten uns inspirieren,
nicht einschränken.

es —
Las paredes deben inspirarnos,
no limitarnos.

Before ...



& after

Instant replay.

Install profiles in repetitive sequences to give your hall depth and structure.

nl —

Instant herhaling. Plaats de profielen in een repetitief patroon om je hal diepte en structuur te geven.

de —

Gleich noch einmal. Verwenden Sie Profile in sich wiederholenden Sequenzen, um Ihrem Flur sofort Tiefe und Struktur zu verleihen.

fr —

Répétition instantanée. Utilisez les profilés dans une séquence répétitive pour donner une profondeur et une structure immédiates à votre couloir.

es —

Reproducción instantánea. Utiliza perfiles en una secuencia repetitiva para dar a tu pasillo una profundidad y estructura instantánea.



1. SX138 p.94 | 2. W121 p.126 | 3. W120 p.126 | 4. C324 p.132 | 5. C344 p.64 | 6. P4025 p.106

Walls are not supposed to be boring

24



nl —

Muren zijn niet gemaakt om saai te blijven.

de —

Wände sind nicht dazu da, langweilig zu sein.

fr —

Les murs ne sont pas faits pour être ennuyeux.

es —

Las paredes no están hechas para ser aburridas.



25

Living Room projects



1. SX163 p.102 | 2. P8030 p.106 | 3. C343 p.68

26



1. SX163 p.102 | 2. C396 p.77



3. SX118 p.93 | 4. P8020 p.106 | 5. C342 p.64

27

Living Room projects



Composed elegance.
Combine multiple cornice mouldings to create a beautiful transition from wall to ceiling.

nl —
Verfijnd veelvoud. Combineer verschillende kroon- en wandlijsten om een unieke overgang tussen wand en plafond te creëren.

fr —
Une élégance composée. Combinez plusieurs corniches et profils pour créer un effet de transition unique entre le mur et le plafond.



1. SX156 p.95 | 2. P8030 p.106 | 3. P8020 p.106 | 4. DX170-2300 p.150 | 5. C362 p.142 | 6. P9901 p.108 | 7. C342 p.81 | 8. P8050 p.106

de —
Harmonische Eleganz. Kombinieren Sie mehrere Stuck- und Wandleisten, um den Übergang von der Wand zur Decke einzigartig wirken zu lassen.

es —
Elegancia compuesta. Combina varias cornisas y perfiles para lograr una transición perfecta de la pared al techo.

GIVE WALLS *PERSONALITY*

CLASSIC



30

MODERN



ZEN



ECLECTIC



31
Living Room projects



Let your
walls
do the
talking



1. W110F p.118 | 2. W110 p.118 | 3. W121 p.126 | 4. W123 p.126 | 5. W120 p.126 | 6. W122 p.126

nl —
Laat je muren aan het woord.

fr —
Laissez vos murs parler.

de —
Lassen Sie Wände sprechen.

es —
Dale voz a tus paredes.



1. SX155 p.96 | 2. D330LR p.150 | 3. DX170-2300 p.150 | 4. C342 p.64



Before ...



36

Highlight the ceiling.

Use led coving for a more spacious effect.

nl —

Licht het plafond uit. Gebruik indirecte verlichting voor een verruimend effect.

fr —

Faites ressortir le plafond. Utilisez un éclairage indirect pour un effet plus spacieux.

de —

Rücken Sie die Decke ins rechte Licht. Erhöhen Sie optisch den Raum mit einer indirekten Beleuchtung und schaffen Sie mehr Räumlichkeit.

es —

Resalta el techo. Opta por la luz indirecta para hacer que tu salón parezca más espacioso.

& after



37

Kitchen projects —

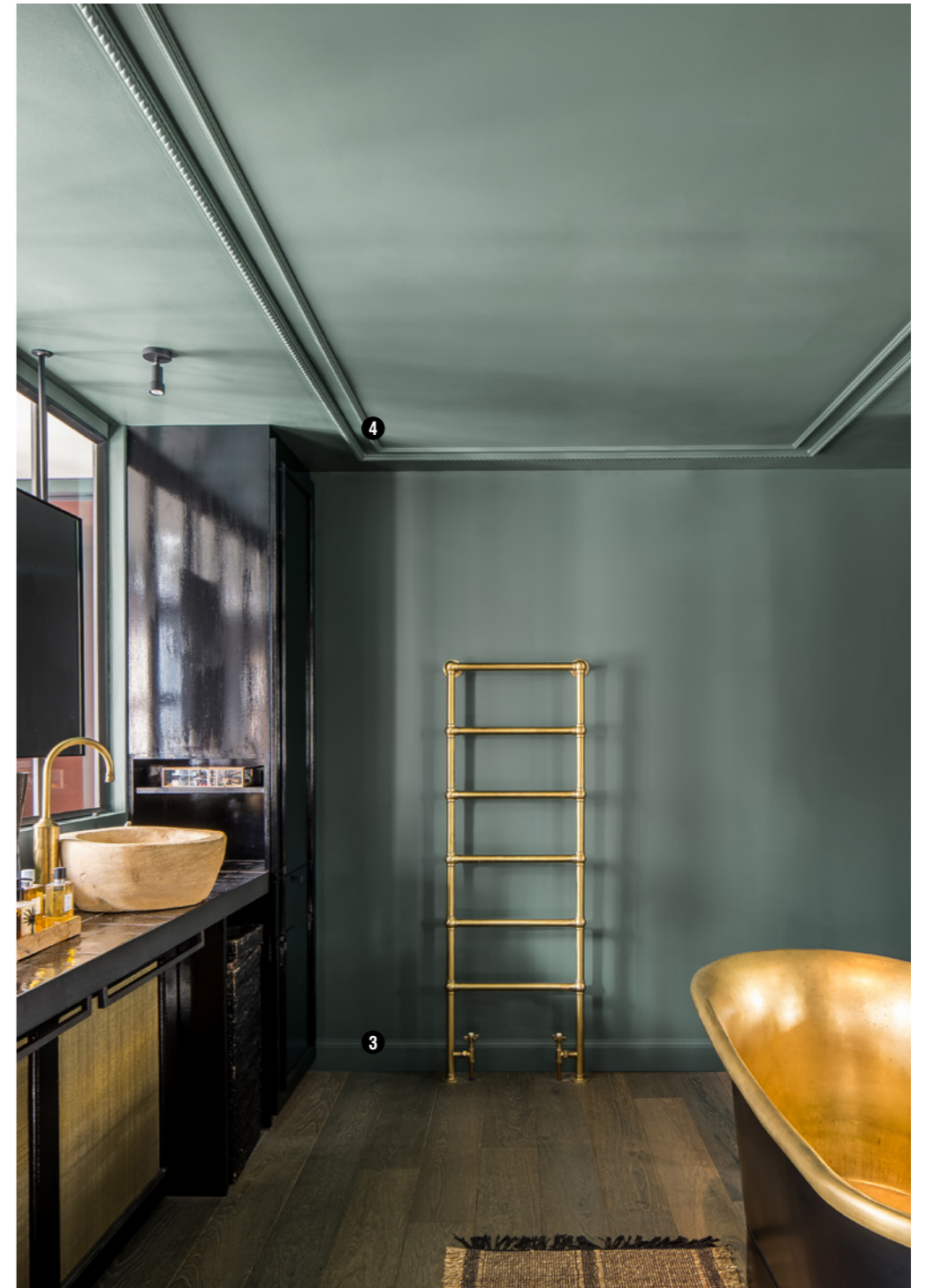

1. PX102 p.111 | 2. PX175 p.111 | 3. SX118 p.93 | 4. PX103 p.111

Walls deserve personality

nl —
Muren verdienen persoonlijkheid.

fr —
Les murs méritent une vraie personnalité.

de —
Wände verdienen Persönlichkeit.

es —
Tus paredes también merecen personalidad.



1. SX162 p.102 | 2. C396 p.77

Combine modern and classic.

Discover how traditional skirting boards and wall mouldings perfectly complement a contemporary cornice.



3. SX118 p.93 | 4. P8030 p.106 | 5. P4020 p.106 | 6. C343 p.68

nl —

Combineer modern met klassiek. Ontdek hoe traditionele plinten en kaders perfect samengaan met een hedendaagse kroonlijst.

de —

Kombinieren Sie Modernes und Traditionelles zusammen. Erleben Sie, wie klassische Sockel- und Wandleisten eine moderne Stuckleiste perfekt ergänzen.

fr —

Combinez modernité et classicisme. Découvrez comment les plinthes et les cimaises traditionnelles complètent parfaitement une corniche contemporaine.

es —

Combina lo moderno y lo clásico. Descubre de qué manera los zócalos y las molduras tradicionales complementan a la perfección una cornisa contemporánea.

GIVE WALLS *PERSONALITY*

ZEN



42

CLASSIC



ECLECTIC



MODERN



43

Bathroom projects

Bring your walls



to life

nl —

Laat je muren tot leven komen.

fr —

Donnez vie à vos murs.

de —

Erwecken Sie Wände zum Leben.

es —

Dale vida a tus paredes.



1. SX118 p.93 | 2. PX103 p.111 | 3. C343 p.64



Well-dressed windows.
Use our curtain profiles to hide your curtain rails in an instant for non-stop elegance.



3. C342 p.81



nl —
Goed geklede ramen. Gebruik onze gordijnprofielen om je gordijnrails te verbergen voor onmiddellijke elegantie.

fr —
Des fenêtres bien habillées. Utilisez nos profils de rideaux pour cacher vos tringles afin d'obtenir une élégance instantanée.

de —
Gut gekleidete Fenster. Mit unseren Gardinenleisten verbergen Sie geschickt und auf elegante Weise störende Vorhangschienen.

es —
Ventanas bien vestidas. El diseño de nuestras cortinas te ayudará a ocultar los rieles y obtener una elegancia instantánea.

GIVE WALLS *PERSONALITY*

MODERN

48



CLASSIC



ECLECTIC



ZEN



49
Bedroom projects



1. W109 p.118 | 2. W109F p.118 | 3. SX105 p.96 | 4. P7070 p.108 | 5. SX187 p.102



nl —

Elke muur is een uitnodiging om iets moois te creëren.

fr —

Chaque mur est une invitation à créer de la beauté.

de —

Jede Wand ist eine Einladung, um etwas Schönes zu schaffen.

es —

Cada pared es una invitación para crear belleza.

Every wall is an invitation
to create beauty



1. P3020 p.107 | 2. P3020A p.115 | 3. P8040 p.106 | 4. SX118 p.93 | 5. P8020 p.106 | 6. P8030 p.106 | 7. C343 p.81

nl —

Groots effect.
Hoge lambrisering in een mum van tijd. De voorgemaakte panelen installeer je rechtstreeks op de muur zonder voorbereidende werken.

de —

Sofortige Wirkung.
Eine fertige Wandvertäfelung in kürzester Zeit. Die vorgefertigten Paneele werden direkt an der Wand angebracht, ganz ohne Vorbereitung.

fr —

Grand effet.
Des lambris hauts en un rien de temps. Les panneaux prêts à l'emploi peuvent être installés directement sur vos murs sans préparation.

es —

Gran efecto.
¿Quieres darle vida rápidamente a tus paredes? Los paneles prefabricados se instalan directamente en la pared sin necesidad de preparar nada previamente.



Immediate effect.
Tall wainscoting in no time. These pre-fabricated panels can be mounted directly to the wall without any prep work.

54



1. SX191 p.95 | 2. W121 p.126 | 3. W120 p.126 | 4. C324 p.132 | 5. C990 + P9900 p.75

55

Bar | Resto | Hotel projects

ASTORIA — DE HAAN (BE)



56



1. SX168 p.102 | 2. SX162 p.113

Engineered Materials

INGENIEUZE MATERIALEN / MATÉRIAUX TECHNIQUES
DURCHDACHTE MATERIALEN / MATERIALES DE INGENIERÍA

PUROTOUCH[®]

A high-quality, high-density polyurethane that allows fine details.

Een kwalitatieve polyurethaan van hoge dichtheid die scherpe details mogelijk maakt.

Un polyuréthane de qualité à haute densité qui permet de créer des détails fins.

Ein qualitativ hochwertiges Polyurethan hoher Dichte, das schöne Details möglich macht.

Un poliuretano de alta densidad y calidad con el que crear pequeños detalles.

Detail Design ★★ ★
Impact Resistance ★★



DUROPOLYMER[®]

An extruded and impact-resistant polymer based on a high-density polystyrene.

Geëxtrudeerde en impactbestendige polystyreenmix van hoge dichtheid.

Un polymère extrudé résistant aux impacts à base d'un mélange de polystyrènes haute densité.

Extrudierter und schlagfester, hochdichter Polystyrol-Mix.

Polímero fabricado por extrusión, resistente a impactos fuertes a base de una mezcla de poliestireno de alta densidad.

Detail Design ★★ ★
Impact Resistance ★★ ★



DUROFOAM[®]

An extruded lightweight polymer based on a medium-density polystyrene blend.

Geëxtrudeerde lichtgewicht polystyreenmix van medium dichtheid.

Un polymère léger extrudé à base d'un mélange de polystyrènes de densité moyenne.

Extrudiertes, leichtes Polymer auf der Grundlage eines Polystyrol-Mix mittlerer Dichte.

Polímero extrusionado de peso ligero a base de una mezcla de poliestireno de densidad media.

Detail Design ★
Impact Resistance ★

Advantages

VOORDELEN / AVANTAGES / VORTEILE / VENTAJAS

READY TO PAINT

All of our products are ready to paint. RAL-colours on demand.

Al onze producten worden schilderklaar geleverd. RAL-kleuren op aanvraag.

Tous nos produits sont prêts à peindre. Couleurs RAL sur demande.

Alle unsere Produkte sind bereit zum Beschichten. RAL-Farben auf Anfrage.

Todos nuestros productos están listos para ser pintados. Colores RAL bajo demanda.

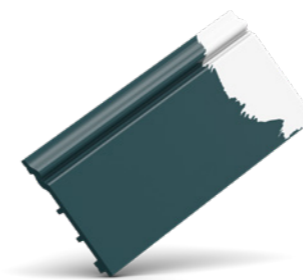

DURABLE

Orac Decor[®] products are designed to last a lifetime. Smart design and high-end technology assure strong and water resistant products.

Orac Decor[®] producten zijn ontwikkeld om een leven lang mee te gaan. Slim productdesign en state-of-the-art technologie verzekeren sterke en waterbestendige producten.

Les produits Orac Decor[®] sont conçus pour durer toute une vie. Une conception intelligente et une technologie haut de gamme garantissent des produits robustes et résistants à l'eau.

Orac Decor[®]-Produkte halten ein Leben lang. Intelligentes Design und hochwertige Technologie sorgen für robuste und absolut wasserbeständige Produkte.

Los productos de Orac Decor[®] están diseñados para durar toda la vida. Gracias a su diseño inteligente y la tecnología de vanguardia, se trata de productos sólidos y resistentes al agua.

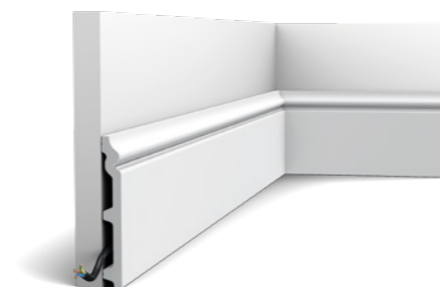

LEGEND

SX118 | SX118F | SX118 - RAL9003
200 x 13,8 x 1,8 cm
Duropolymer[®]

F = Flexible polyurethane version
RAL 9003 = Finished with RAL9003 (white, on stock)
Dimensions
Material

Product Overview

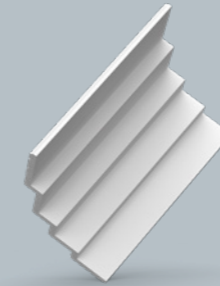

Cornice Mouldings

Kroonlijsten / Corniches / Stuckleisten / Cornisas

Pg.62



Skirting Boards

Plinten / Plinthes / Sockelleisten / Zócalos

Pg.88

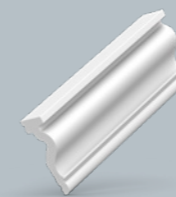

Panel Mouldings

Wandlijsten / Cimaises
Wand- und Friesleisten / Molduras

Pg.104



3D Wall Covering

3D Wandbekleding / Revêtements muraux 3D
3D Wandvertäfelung / Revestimiento de pared 3D

Pg.116



Led Coving

Indirecte Verlichting / Éclairage Indirect
Indirekte Beleuchtung / Iluminación Indirecta

Pg.130

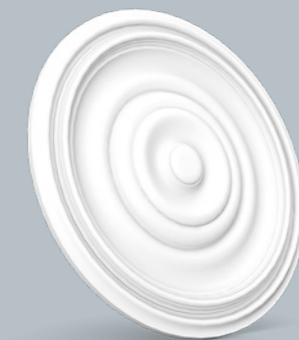

Deco Elements

Decoratieve Elementen / Éléments Décoratifs
Zierelemente / Elementos de Decoración

Pg.144

The Perfect Finish

De Perfecte Afwerking / La Finition Parfaite / Die perfekte Installation / El Acabado Perfecto

Pg.154



Cornice Mouldings

KROONLIJSTEN / CORNICHES
STUCKLEISTEN / CORNISAS

62



en —

Your walls don't stop when they touch the ceiling. Add a splash of your personality to this transition area – and let it continue onto the ceiling with our cornice mouldings. Available in a range of styles from sleek to baroque, from decorative to functional.

nl —

Je muren stoppen niet wanneer ze het plafond bereiken. Geef een vleugje persoonlijkheid mee aan deze overgangszone en laat haar doorlopen tot op het plafond met onze kroonlijsten. Verkrijgbaar in een waaier aan stijlen van strak tot barok, van decoratief tot functioneel.

fr —

Vos murs ne s'arrêtent pas lorsqu'ils arrivent au plafond. Ajoutez une touche de personnalité à cette zone de transition et laissez-la continuer vers le plafond avec nos corniches. Disponible dans une gamme de styles allant du style épuré au baroque, du style décoratif au style fonctionnel.

de —

Ihre Wände enden nicht an der Decke. Verleihen Sie diesem Übergangsbereich einen Hauch von Individualität und führen Sie unsere Stuckleisten an der Decke weiter. Erhältlich in einer Reihe von Stilen von schlicht bis barock, von dekorativ bis funktionell.

es —

Tus paredes no se detienen al tocar el techo. Añade un toque de personalidad a esta zona de transición y deja que continúe en el techo gracias a nuestras cornisas. Disponible en una amplia gama de estilos, desde elegantes a barrocos, y desde decorativos a funcionales.

63

1. SX118 p.93 | 2. P4020 p.106 | 3. P8020 p.106 | 4. C344 p.64 | 5. P8030 p.106



C325 | C325F MANOIR
200 x 7 x 6,5 cm
Purotouch®

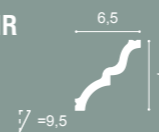

C326 | C326F MANOIR
200 x 10,5 x 9 cm
Purotouch®

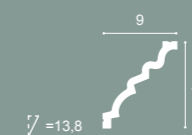

9 C327 MANOIR
200 x 14,3 x 15,9 cm
Purotouch®

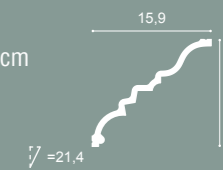

64

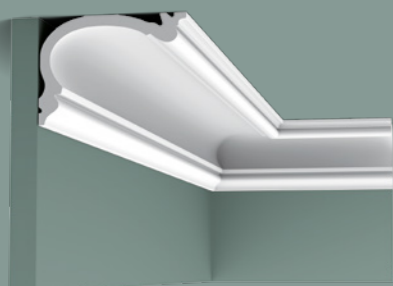

C341 | C341F HERITAGE
200 x 8,8 x 12,2 cm
Purotouch®

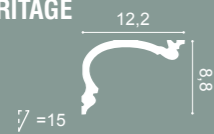

C342 HERITAGE
200 x 14 x 19 cm
Purotouch®

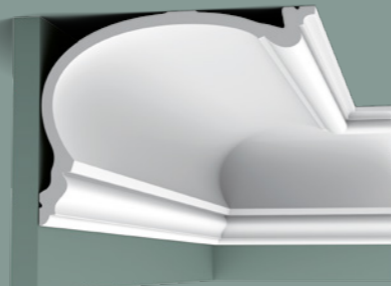
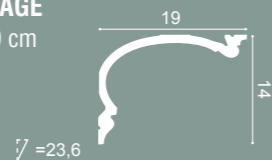

C343 HERITAGE
200 x 19 x 25 cm
Purotouch®

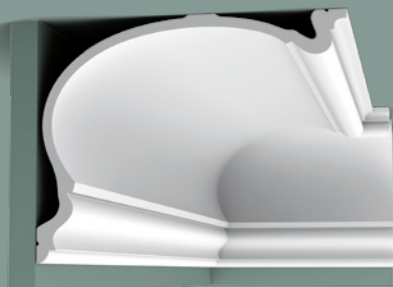
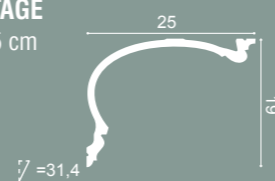

4 C344 HERITAGE
200 x 27,3 x 35 cm
Purotouch®

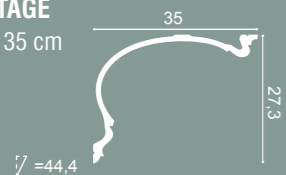

6. SX191 p.95 | 7. P4020 p.106 | 8. P8020 p.106 | 9. C327 p.65

65



C338 BA'ROCK
200 x 18,2 x 18,2 cm
Purotouch[®]

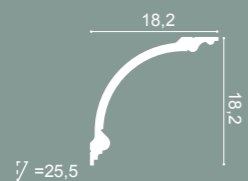

C336 BA'ROCK
200 x 27,1 x 26,6 cm
Purotouch[®]

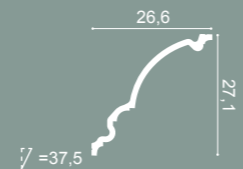

1 C338B BA'ROCK
200 x 18,2 x 18,2 cm
Dessin: 2 x 57 cm
Purotouch[®]

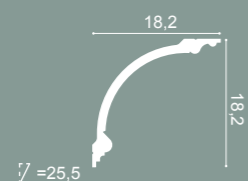

C338A BA'ROCK
200 x 18,2 x 18,2 cm
Dessin: 120 cm
Purotouch[®]

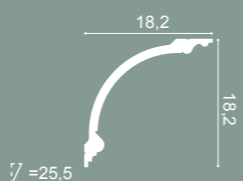

C230 | C230F
200 x 2,9 x 2,9 cm
Purotouch[®]

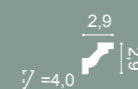

C215 | C215F
200 x 4,7 x 4,7 cm
Purotouch[®]

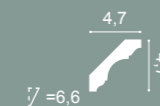

C322
200 x 5 x 4,2 cm
Purotouch[®]

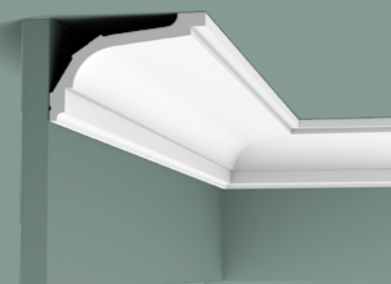
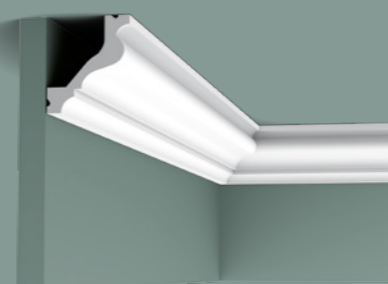
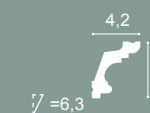

C200
200 x 6,5 x 5,7 cm
Purotouch[®]



C220 | C220F
200 x 7,6 x 11,6 cm
Purotouch[®]

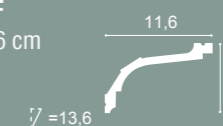

C213 | C213F
200 x 8 x 8 cm
Purotouch[®]

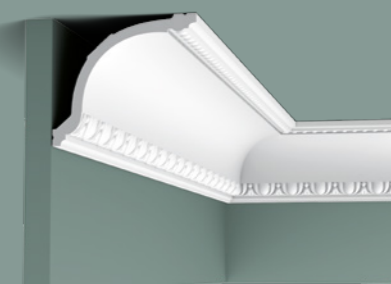
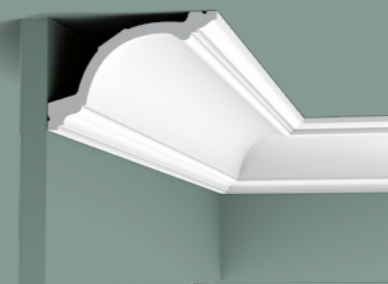

C217 | C217F
200 x 10,3 x 15,6 cm
Purotouch[®]

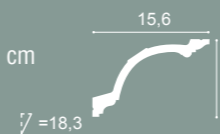

C217 | C217F
200 x 15,6 x 10,3 cm
Purotouch[®]

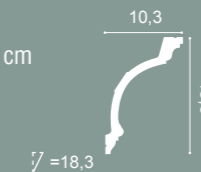

C216
200 x 11,6 x 13,3 cm
Purotouch[®]

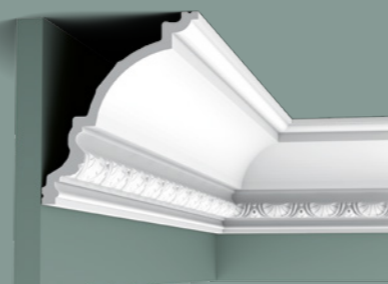
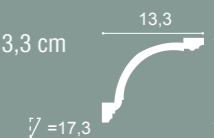

C301
200 x 17 x 14,4 cm
Purotouch[®]

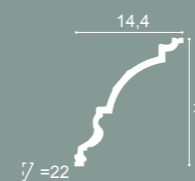



C333 | C333F
200 x 12,2 x 11,1 cm
Purotouch®

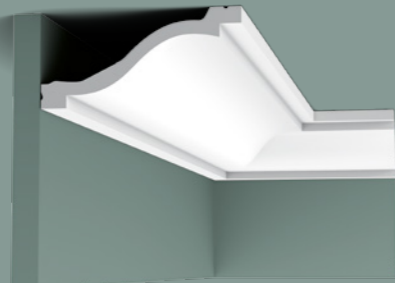
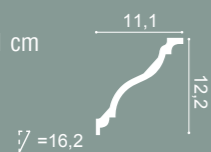

C331 | C331F
200 x 6,4 x 13,5 cm
Purotouch®

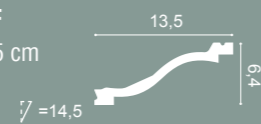

C334 | C334F
200 x 15 x 19,6 cm
Purotouch®

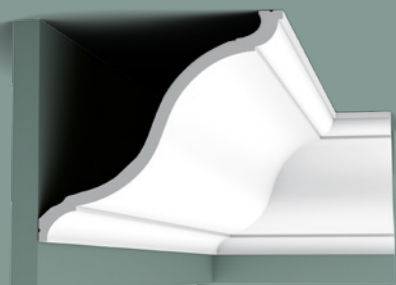
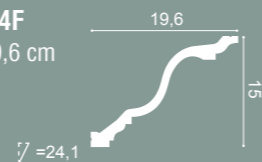

C335
200 x 20,2 x 22,2 cm
Purotouch®
Designed by
Xavier Donck

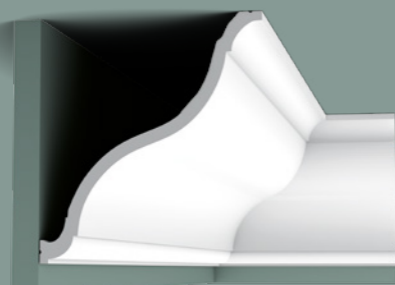
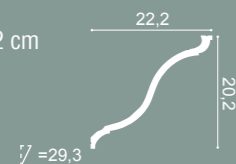

C335
200 x 22,2 x 20,2 cm
Purotouch®
Designed by
Xavier Donck

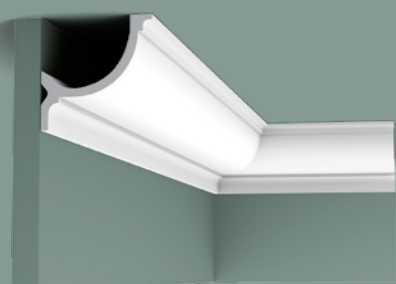
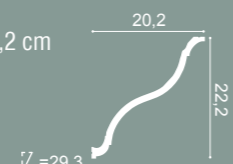

C902 | C902F
200 x 10,3 x 10,3 cm
Purotouch®

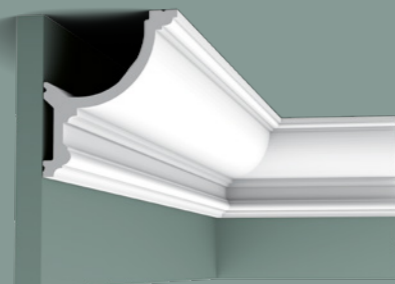
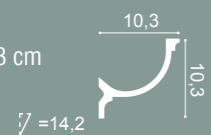

C901 | C901F
200 x 14,8 x 12,4 cm
Purotouch®

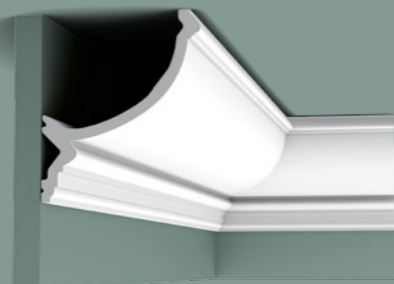

C900
200 x 17,1 x 14,6 cm
Purotouch®

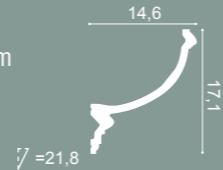

68



1. SX156 p.95 | 2. P8020 p.106 | 3. C901 p.68

69

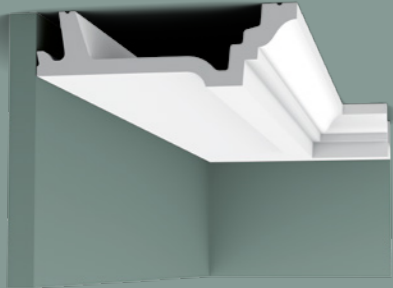

C305
200 x 4,7 x 15,5 cm
Purotouch®
15,5
4,7
5,6
15,9

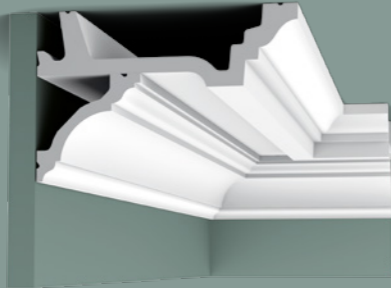

C305 + C213
15,5
4,7
8
8
19,3

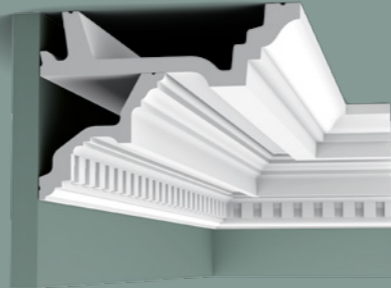

C305 + C211
15,5
4,7
5,6
11,6
11,2
21,5

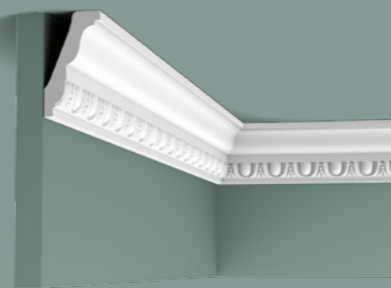

C212
200 x 7,5 x 4,5 cm
Purotouch®
4,5
7,5
8,5



C201
200 x 11,6 x 4,8 cm
Purotouch®
4,8
11,6
12,5

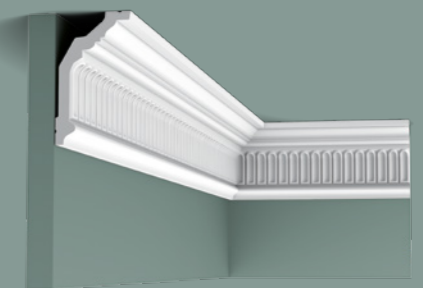

C304 | C304F
200 x 12,2 x 7,2 cm
Purotouch®
7,2
12,2
13,9



C211 | C211F
200 x 11,6 x 11,2 cm
Purotouch®
11,2
11,6
15,8



C422
200 x 16,4 x 19,4 cm
Purotouch®
19,4
16,4
25,4



C303
200 x 14,4 x 6,5 cm
Purotouch®
6,5
14,4
15,3



4 C219
200 x 17,6 x 13 cm
Purotouch®
13
17,6
21,8



C308
200 x 24,8 x 6,3 cm
Purotouch®
6,3
24,8
25

70

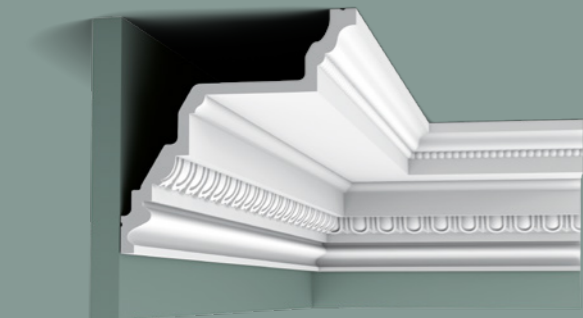

C307
200 x 19,5 x 19,5 cm
Purotouch®
19,5
19,5
26,5

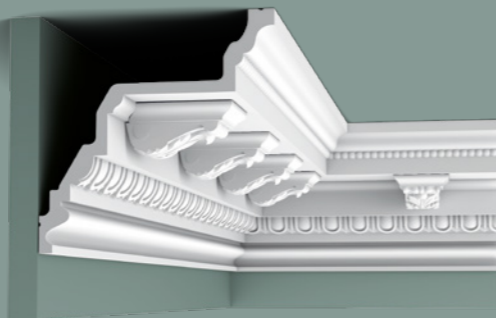

1 C307 + C307A 2
C307A: 7,5 x 4 x 9,4 cm
Duropolymer®
19,5
9,4
4
9,4
26,9



3. P8020 p.106 | 4. C219 p.71

71



C321 | C321F
200 x 9,9 x 5 cm
Purotouch®

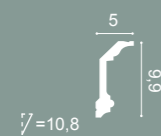

C339 | C339F
200 x 14,1 x 6,4 cm
Purotouch®

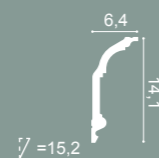

4 C332
200 x 23 x 11,4 cm
Purotouch®

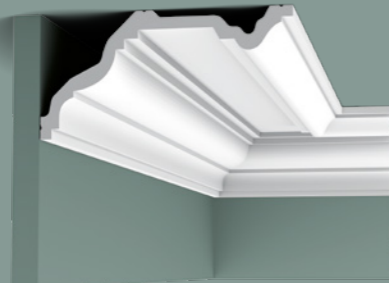
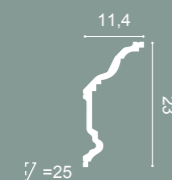

C332
200 x 11,4 x 23 cm
Purotouch®



C340
200 x 25,6 x 13,5 cm
Purotouch®

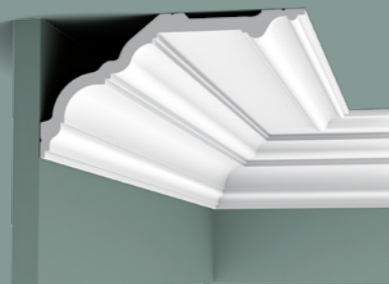
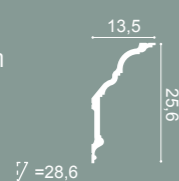

C340
200 x 13,5 x 25,6 cm
Purotouch®

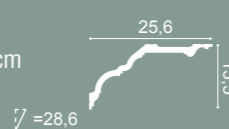

1. SX156 p.95 | 2. DX170-2300 p.150 | 3. C323 p.132 | 4. C332 p.72



C250 | C250F
200 x 1,6 x 1,6 cm
Purotouch®

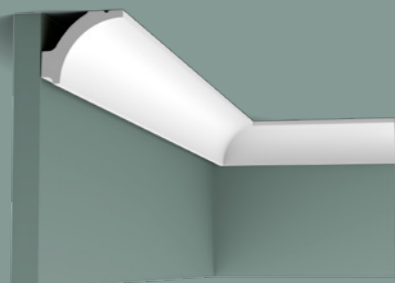
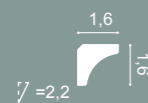

C260
200 x 4,1 x 4,8 cm
Purotouch®

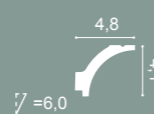

C240 | C240F
200 x 8 x 8 cm
Purotouch®

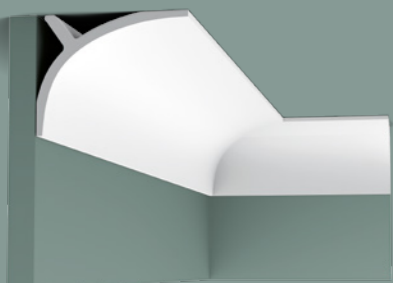
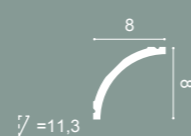

C991
200 x 11 x 14 cm
Purotouch®
Designed by Ulf Moritz

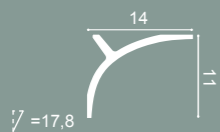

C991 + P9900

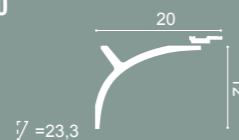

C991 + 2x P9900

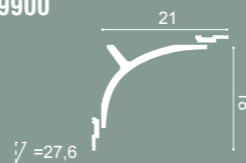

C991
200 x 14 x 11 cm
Purotouch®
Designed by Ulf Moritz

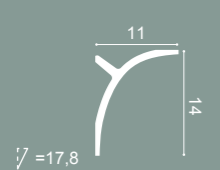

C991 + P9900



C991 + 2x P9900

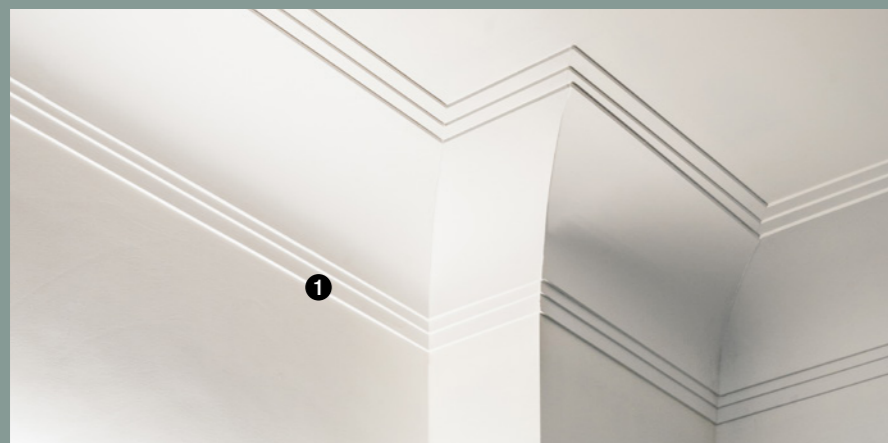
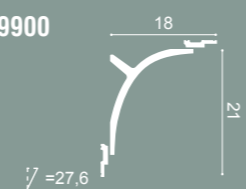

1. C990 + 2x P9900 p.75

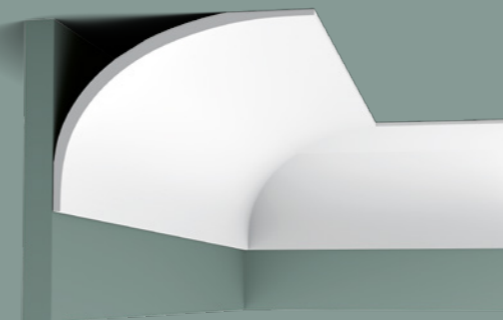

C990 INFINITY
200 x 15,9 x 21,6 cm
Purotouch®
Designed by Xavier Donck

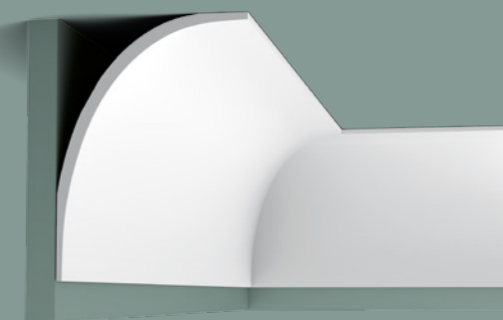
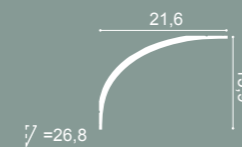

C990 INFINITY
200 x 21,6 x 15,9 cm
Purotouch®
Designed by Xavier Donck

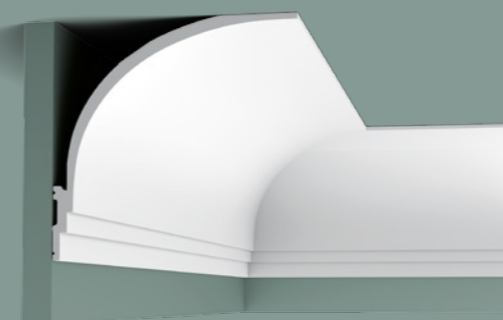
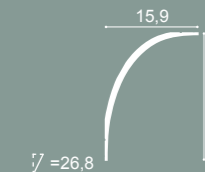

C990 + P9900

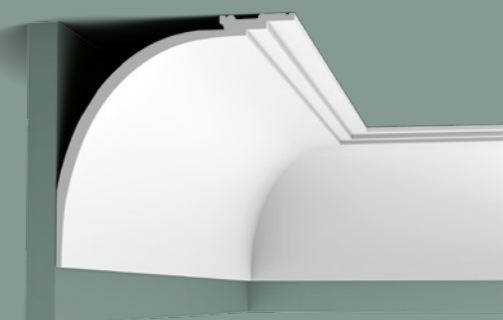
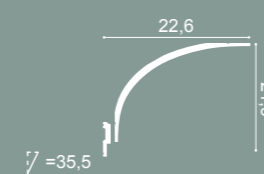

C990 + P9900

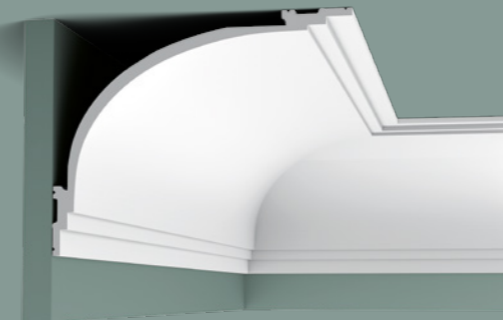
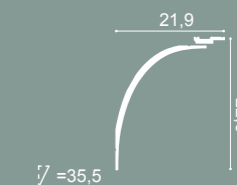

C990 + 2x P9900

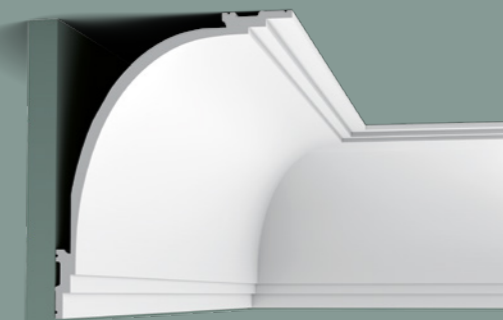
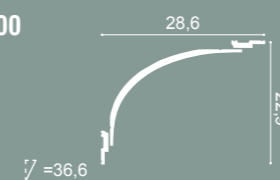

1 C990 + 2x P9900



Steps

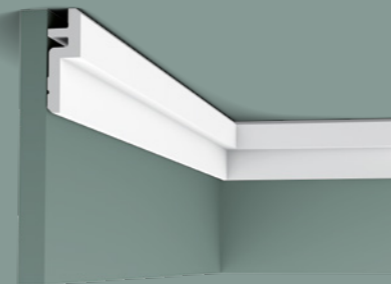

C394 STEPS
200 x 9,5 x 3,1 cm
Purotouch®
Designed by
Orio Tonini

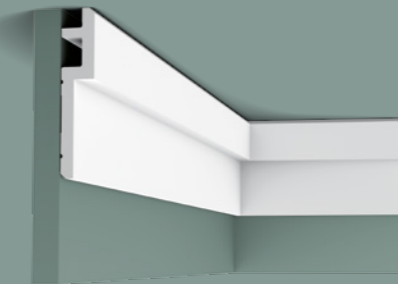

C395 STEPS
200 x 15,5 x 3,1 cm
Purotouch®
Designed by
Orio Tonini

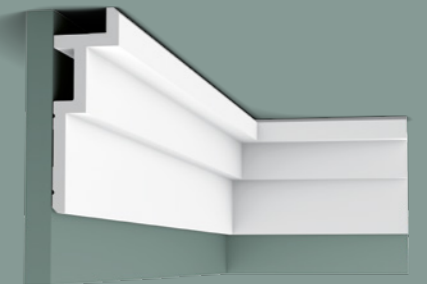

C396 STEPS
200 x 18,5 x 6,1 cm
Purotouch®
Designed by
Orio Tonini

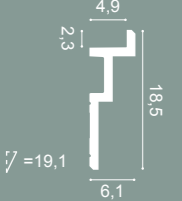

CORNICE MOULDINGS | KROONLIJSTEN | CORNICHES | STUCKLEISTEN | CORNISAS

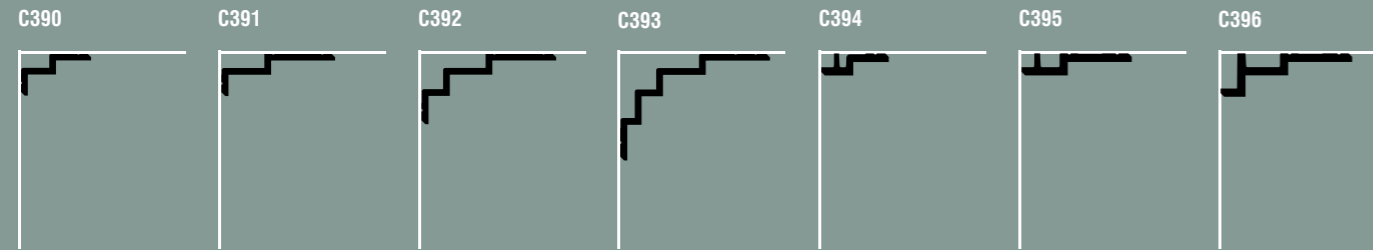

C390 STEPS
200 x 6 x 10 cm
Purotouch®
Designed by
Orio Tonini

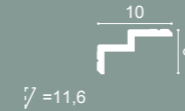

C391 STEPS
200 x 6 x 16 cm
Purotouch®
Designed by
Orio Tonini

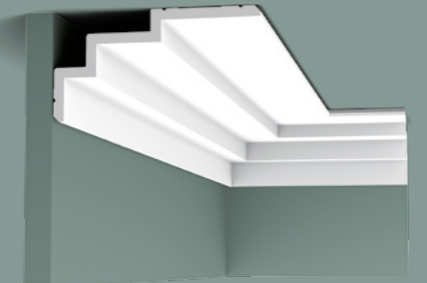

C392 STEPS
200 x 10 x 19 cm
Purotouch®
Designed by
Orio Tonini

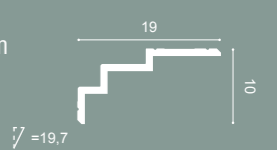

76

BORDER

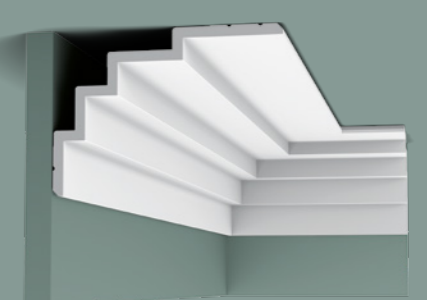
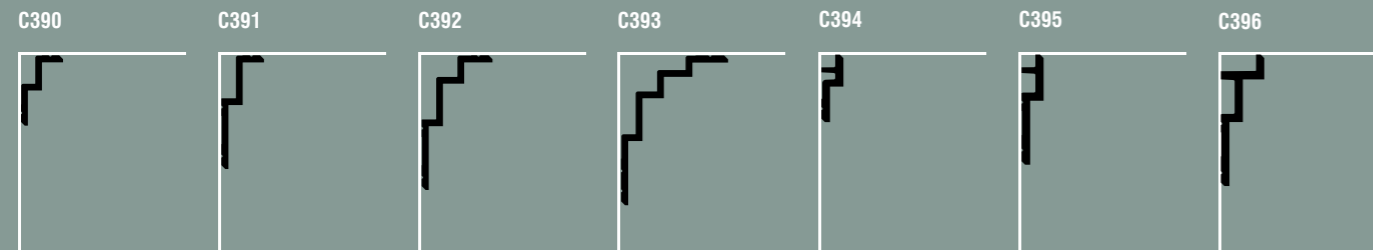

1 C393 STEPS
200 x 15 x 21 cm
Purotouch®
Designed by
Orio Tonini

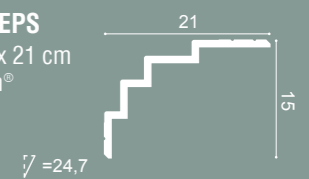

CURTAIN PROFILES | GORDIJNPROFIELEN | PROFILS RIDEAU | GARDINENLEISTEN | CORNISAS PARA CORTINAS

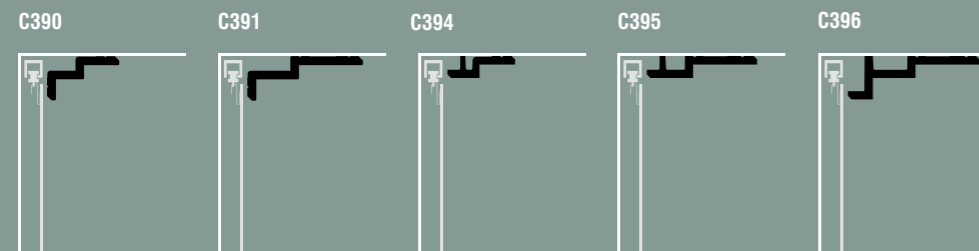

LED COVING | INDIRECTE VERLICHTING | ÉCLAIRAGE INDIRECT | INDIRECTE BELEUCHTUNG | ILUMINACIÓN INDIRECTA

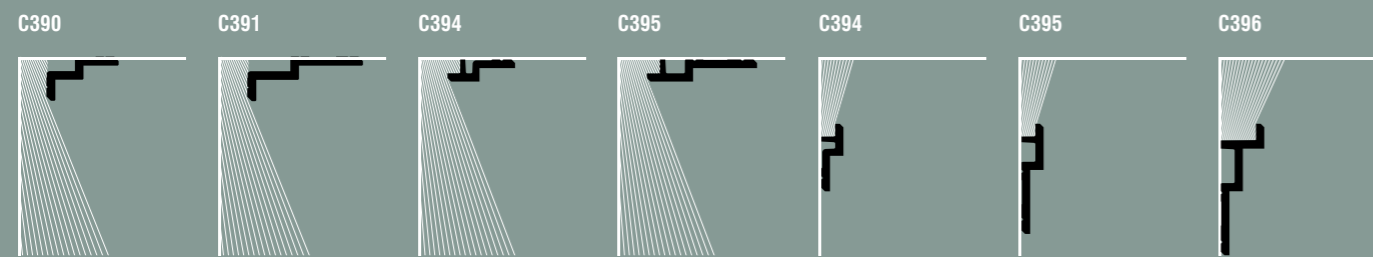

DOWNLIGHTER

UPLIGHTER

1. C393 p.77

77



3 C360
200 x 2,1 x 6 cm
Purotouch®
Designed by
Jacques Vergracht



C356
200 x 2 x 10 cm
Purotouch®
Designed by
Jacques Vergracht



C355
200 x 3,5 x 11,1 cm
Purotouch®
Designed by
Jacques Vergracht



5 C353
200 x 3 x 16,5 cm
Purotouch®
Designed by
Jacques Vergracht

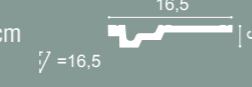

C354
200 x 4 x 21,5 cm
Purotouch®
Designed by
Jacques Vergracht



C602
200 x 5,3 x 5 cm
Purotouch®

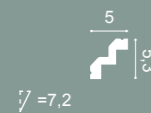

C400
200 x 6 x 10 cm
Purotouch®



Curtain Profiles

GORDIJNPROFIELEN / PROFILS RIDEAU
GARDINENLEISTEN / CORNISAS PARA CORTINAS



1. SX155 p.96 | 2. D330LR p.150 | 3. DX170-2300 p.150 | 4. C342 p.81



C394 STEPS CURTAIN PROFILE
200 x 3,1 x 9,5 cm
Purotouch®
Designed by Orio Tonini

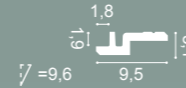

C395 STEPS CURTAIN PROFILE
200 x 3,1 x 15,5 cm
Purotouch®
Designed by Orio Tonini

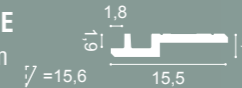

C390 STEPS CURTAIN PROFILE
200 x 6 x 10 cm
Purotouch®
Designed by Orio Tonini

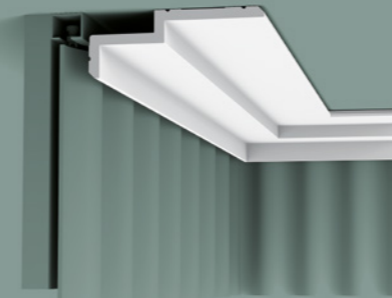

C391 STEPS CURTAIN PROFILE
200 x 6 x 16 cm
Purotouch®
Designed by Orio Tonini



C396 STEPS CURTAIN PROFILE
200 x 6,1 x 18,5 cm
Purotouch®
Designed by Orio Tonini

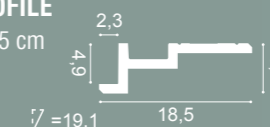

C991 CURTAIN PROFILE
200 x 11 x 14 cm
Purotouch®
Designed by Ulf Moritz

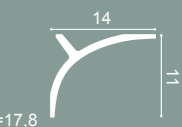

C341 | C341F HERITAGE CURTAIN PROFILE
200 x 8,8 x 12,2 cm
Purotouch®

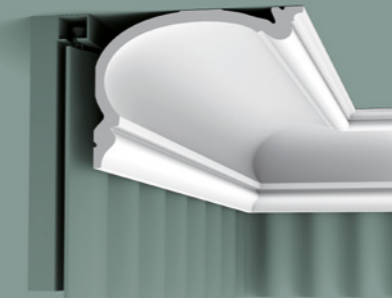
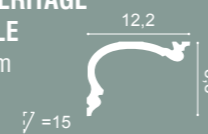

C342 HERITAGE CURTAIN PROFILE
200 x 14 x 19 cm
Purotouch®

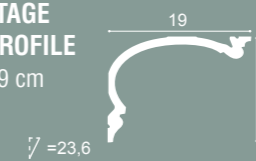

C343 HERITAGE CURTAIN PROFILE
200 x 19 x 25 cm
Purotouch®

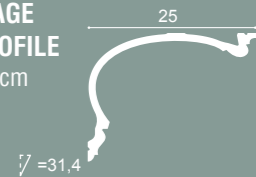

C340 CURTAIN PROFILE
200 x 13,5 x 25,6 cm
Purotouch®

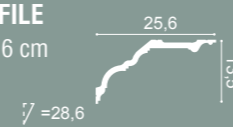

CX196 U-STEPS CURTAIN PROFILE
200 x 4 x 11,3 cm
Duropolymer®
Designed by Orio Tonini



CX197 U-STEPS CURTAIN PROFILE
200 x 5 x 9,3 cm
Duropolymer®
Designed by Orio Tonini





CX124 | CX124F
200 x 4,9 x 4,9 cm
Duropolymer®



CX100 | CX100F
200 x 6,9 x 7,1 cm
Duropolymer®

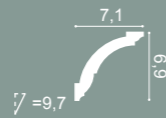

CX123 | CX123F
200 x 8 x 8 cm
Duropolymer®

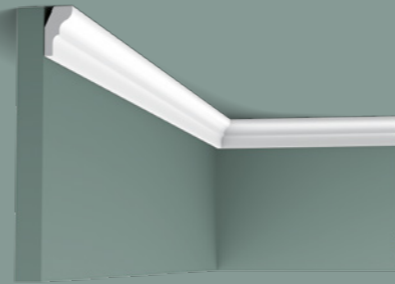

CX111
200 x 2,6 x 1,5 cm
Duropolymer®

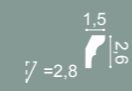

CX154
200 x 3 x 3 cm
Duropolymer®

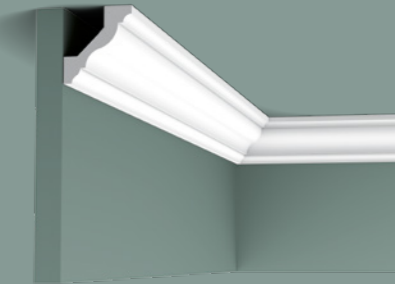
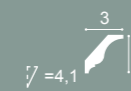

CX110 | CX110F
200 x 4,5 x 4,1 cm
Duropolymer®



5 CX127 | CX127F
200 x 9,4 x 9,4 cm
Duropolymer®



CX199 | CX199F
200 x 8 x 8 cm
Duropolymer®

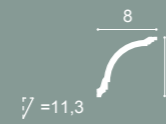

CX106 | CX106F
200 x 11,8 x 11,7 cm
Duropolymer®

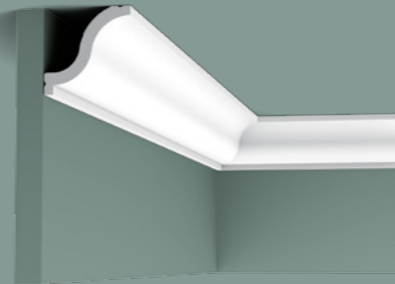
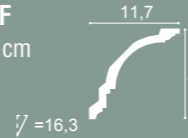

CX108
200 x 5,4 x 5,5 cm
Duropolymer®

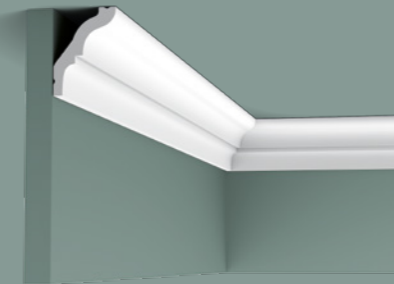
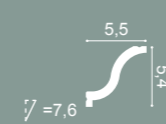

CX112
200 x 5,4 x 3,8 cm
Duropolymer®



CX177
200 x 7 x 6 cm
Duropolymer®



CX203
200 x 14,5 x 14,5 cm
Duropolymer®

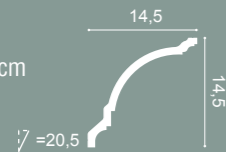

1. SX137 p.94 | 2. PX116 p.111 | 3. PX120 p.111 | 4. PX103 p.111 | 5. CX127 p.82



CX101
200 x 6,9 x 7,1 cm
Duropolymer®

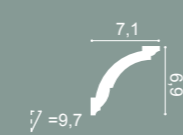

CX129
200 x 9,4 x 9,4 cm
Duropolymer®

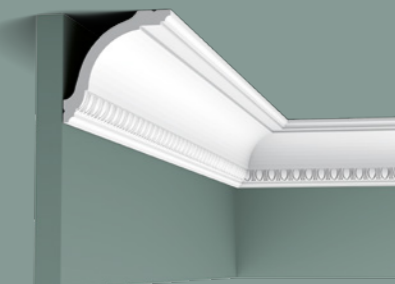

CX128
200 x 9,4 x 9,4 cm
Duropolymer®



CX107
200 x 11,8 x 11,7 cm
Duropolymer®

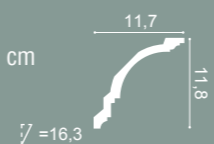

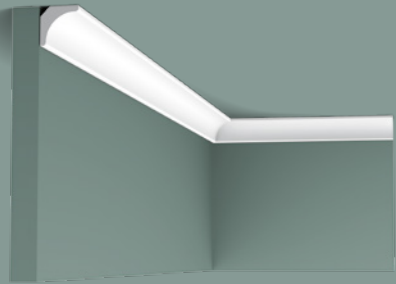

CX133
200 x 2 x 2 cm
Duopolymer®

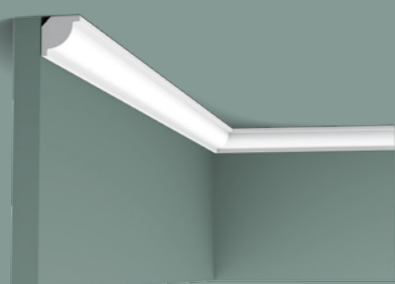
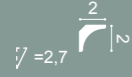

CX132 | CX132F
200 x 2 x 2 cm
Duopolymer®

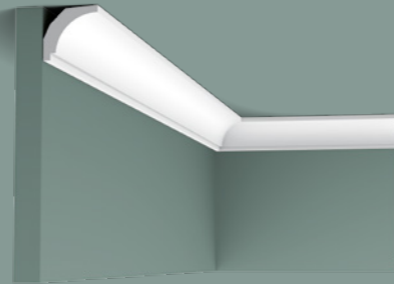
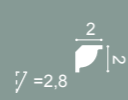

CX115
200 x 3 x 2,9 cm
Duopolymer®

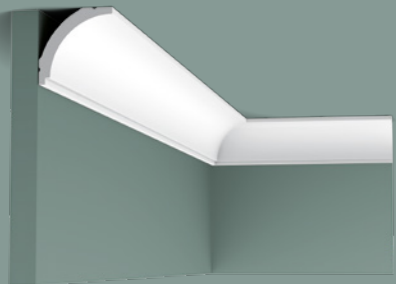
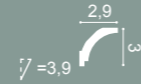

CX109 | CX109F
200 x 4,4 x 4,4 cm
Duopolymer®

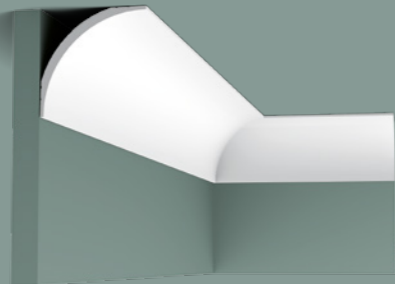
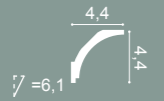

CX126
200 x 8,7 x 8,7 cm
Duopolymer®

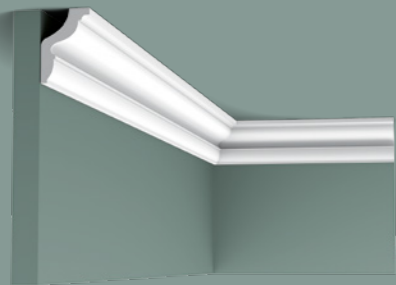
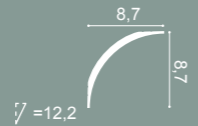

CX148
200 x 4,3 x 2,9 cm
Duopolymer®

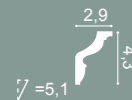

CX141
200 x 5,9 x 3,1 cm
Duopolymer®

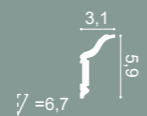

CX176
200 x 8 x 4 cm
Duopolymer®

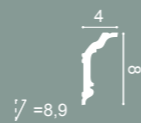

CX192
200 x 12 x 6 cm
Duopolymer®

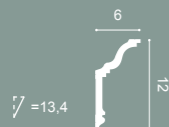

1. PX198 p.112 | 2. CX196 p.138 | 3. CX197 p.85



CX190 | CX190F U-PROFILE
200 x 3 x 2 cm
Duopolymer®
Designed by Orio Tonini

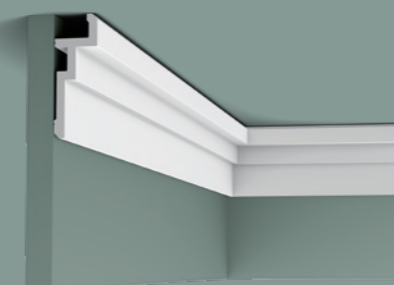

CX196 U-STEPS
200 x 11,3 x 4 cm
Duopolymer®
Designed by Orio Tonini

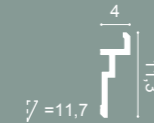

CX197 U-STEPS
200 x 9,3 x 5 cm
Duopolymer®
Designed by Orio Tonini

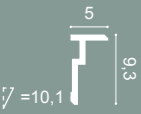

PX198 | PX198F U-STEPS
200 x 2 x 8,3 cm
Duopolymer®
Designed by Orio Tonini



PX198 | PX198F U-STEPS
200 x 2 x 8,3 cm
Duopolymer®
Designed by Orio Tonini





SX194 | SX194F SQUARE
200 x 1 x 2 cm
Duropolymer®

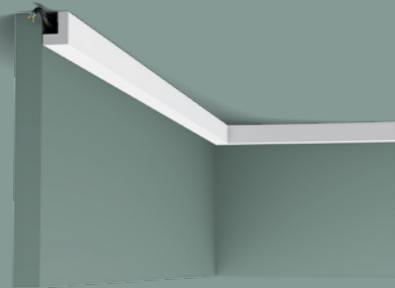

PX164
200 x 3 x 2,4 cm
Duropolymer®



SX162 | SX162F SQUARE
200 x 1 x 4 cm
Duropolymer®



SX157 | SX157F SQUARE
200 x 1,3 x 6,6 cm
Duropolymer®



SX163 | SX163F SQUARE
200 x 1,3 x 10,1 cm
Duropolymer®



SX182 | SX182F CASCADE
200 x 1,3 x 5 cm
Duropolymer®

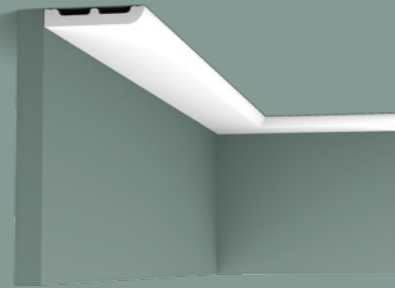

SX183 | SX183F CASCADE
200 x 1,3 x 7,5 cm
Duropolymer®



SX184 | SX184F CASCADE
200 x 1,3 x 11 cm
Duropolymer®



CX160
200 x 1,3 x 3,9 cm
Duropolymer®



CX161
200 x 1,3 x 6,9 cm
Duropolymer®



PB513
200 x 1,5 x 3,4 cm
Durofoam®

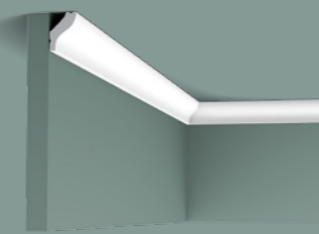

CB500
200 x 2,5 x 1,8 cm
Durofoam®



CB530
200 x 2,7 x 1,5 cm
Durofoam®

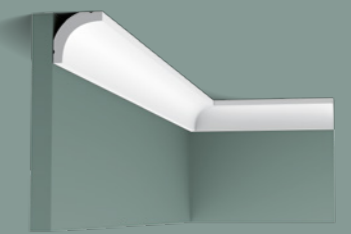

CB520
200 x 3,5 x 3,5 cm
Durofoam®



CB510
200 x 4 x 4 cm
Durofoam®



CB501
200 x 4,1 x 3,5 cm
Durofoam®



CB531
200 x 4,8 x 2,6 cm
Durofoam®



CB521
200 x 5 x 5 cm
Durofoam®

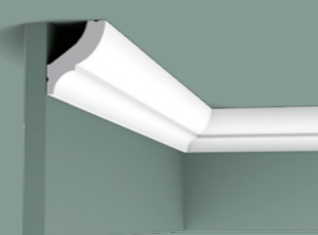

CB502
200 x 5,9 x 4,9 cm
Durofoam®



CB523
200 x 5,9 x 4,4 cm
Durofoam®



CB525
200 x 6,5 x 6 cm
Durofoam®



CB511
200 x 6,7 x 6,7 cm
Durofoam®

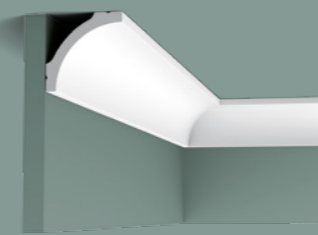

CB522
200 x 6,7 x 6,7 cm
Durofoam®

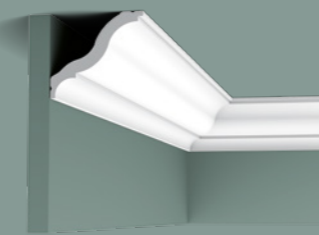

CB503
200 x 8,2 x 9,2 cm
Durofoam®

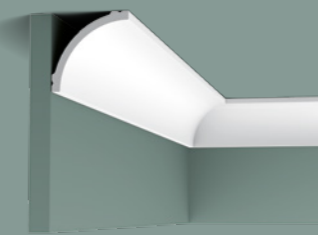

CB524
200 x 9 x 9 cm
Durofoam®



CB512
200 x 9,5 x 10 cm
Durofoam®



Skirting Boards

PLINTEN / PLINTHES
SOCKELLEISTEN / ZÓCALOS



88

89

en —

Modern or rustic. Large or small. Striking or discrete. Whatever your style, you'll find the skirting boards your home deserves in a design you'll love. Looking for a hassle-free solution? Our superior Duropolymer[®] quality is fully impact- and water-resistant.

nl —

Modern of rustiek. Klein of groot. Opvallend of discreet. Wat jouw stijl ook mag zijn, je zal de plint vinden die je huis verdient in een ontwerp waar je dol op bent. Op zoek naar een zorgeloze oplossing? Onze uitzonderlijke Duropolymer[®]-kwaliteit is bijzonder impact- en waterbestendig.

fr —

Moderne ou rustique. Grand ou petit. Spectaculaire ou discret. Quel que soit votre style, vous trouverez la plinthe que votre maison mérite dans un design que vous adorerez. Vous cherchez une solution simple ? Notre Duropolymer[®] de qualité supérieure est entièrement résistant aux chocs et à l'eau.

de —

Modern oder rustikal. Groß oder klein. Markant oder diskret. Egal welchen Stil Sie sich vorstellen, bei uns finden Sie Sockelleiste, die Ihr Zuhause verschönert, in einem Design, das Sie begeistern wird. Suchen Sie eine unkomplizierte Lösung? Unsere erstklassige Duropolymer[®]-Qualität ist absolut schlagfest und wasserbeständig.

es —

Moderno o rústico. Grande o pequeño. Impactante o discreto. Sea cual sea tu estilo, tenemos el zócalo que tu hogar merece y en un diseño que te encantará. ¿Quieres una opción que no te dé problemas más adelante? Trabajamos con Duropolymer[®], un material de primera calidad totalmente resistente a los impactos y al agua.

DUROPOLYMER®

LOVES...

nl —

Duropolymer® houdt van verf, is reeds geprimed en makkelijk af te werken met kwaliteitsverf. Duropolymer® houdt van water maar wordt nooit nat, is waterbestendig en dimensioneel stabiel. Duropolymer blinkt uit met haarscherpe lijnen en fijne weergave van alle details. Duropolymer® houdt van hard werk en is bijzonder schok-, impact- en krasbestendig. Duropolymer® blijft graag hangen, is lichtgewicht en makkelijk te installeren met de Orac Decor® DecoFix lijmen. Duropolymer® is duurzaam, wordt geproduceerd met 40% hernieuwbare energie, is 100% recycleerbaar en bevat geen toxische stoffen.

fr —

Duropolymer® aime la peinture, est livré avec un apprêt et est facile à finir avec n'importe quel type de peinture de qualité. Duropolymer® aime l'eau mais ne devient jamais humide, résiste à l'eau et est dimensionnellement stable. Duropolymer® aime se démarquer par ses bords tranchants et ses détails raffinés pour un design haute définition. Duropolymer® aime travailler, résiste aux chocs, aux rayures et aux impacts. Duropolymer® aime bien se tenir, est léger et facile à installer avec les colles Orac Decor® DecoFix. Duropolymer® aime la durabilité, est fabriqué avec un recyclage intégré, est 100 % recyclable et ne contient aucun produit toxique.

de —

Duropolymer® liebt Farbe, wird bereits grundiert geliefert und lässt sich leicht mit jeder Art von hochwertiger Farbe veredeln. Duropolymer® liebt Wasser, wird aber nie nass – es ist wasserfest und formstabil. Duropolymer® liebt es, sich durch klar definierte Kanten und präzise Details auszuzeichnen – für ein hochwertiges Design. Duropolymer® liebt harte Arbeit – es ist robust, stoß-, schlag- und kratzfest. Duropolymer® liebt es, an Wand und Decke zu hängen – es ist ein Leichtgewicht und mit den DecoFix-Klebern von Orac Decor® ganz einfach anzubringen. Duropolymer® liebt Nachhaltigkeit, wird recyclingfähig hergestellt, ist zu 100 % wiederverwertbar und enthält keine toxischen Produkte.

es —

Duropolymer® admite a la perfección la pintura, viene imprimado y es fácil de terminar con cualquier tipo de pintura, esmalte o laca en base agua de calidad. A Duropolymer® le encanta el agua, pero nunca se moja, es impermeable y de dimensiones estables. Resulta ideal para hacerlo resaltar con bordes afilados y detalles finos que le confieran un diseño de alta definición. A Duropolymer® le gusta el trabajo duro, y es resistente a golpes, impactos y arañazos. También le encanta quedar colgado; es ligero y fácil de instalar con pegamentos Orac Decor® DecoFix. Ante todo, es un material sostenible. Se elabora a partir de un reciclaje integrado, es 100% reciclable y no contiene productos tóxicos.



PAINT

primed and easy to finish with any type of quality paint

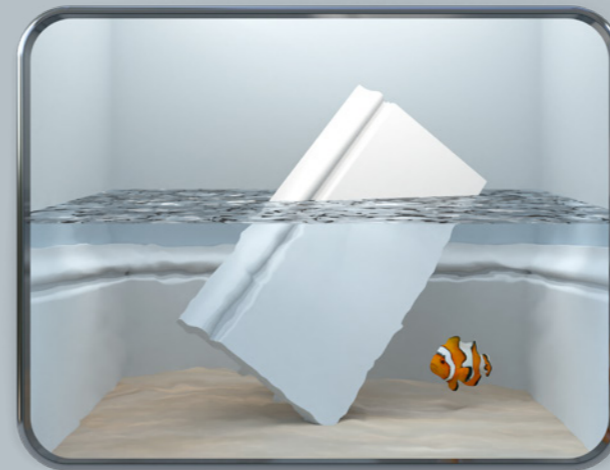

WATER

but never gets wet; water resistant and dimensionally stable

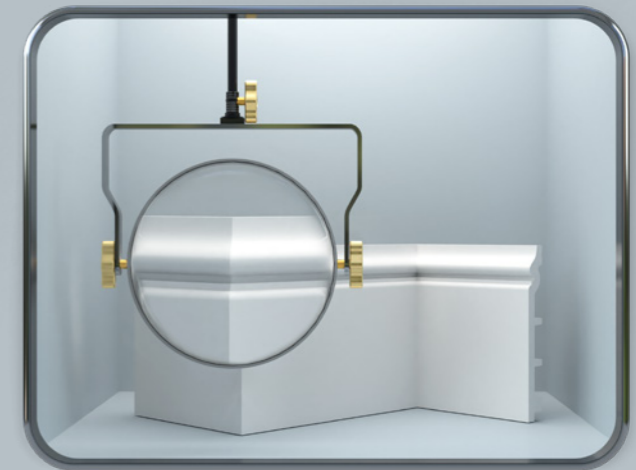

TO STAND OUT

sharp edges and fine details for high-definition design



HARD WORK

knock-, impact- and scratch-resistant



TO HANG AROUND

lightweight and easy to install with Orac Decor® DecoFix glues



SUSTAINABILITY

produced with 40% renewable energy, 100% recyclable, contains no toxic products

3 essential Skirting Board families

CHOOSE YOUR STYLE. GET CREATIVE.

nl —

3 essentiële families plinten.
Kies je stijl. Wees creatief.

fr —

3 essentielles familles de plinthes.
Choisissez votre style. Faites preuve de créativité.

de —

3 wesentliche Sockelleisten-Familien.
Wählen Sie Ihren Stil. Werden Sie kreativ.

es —

3 familias de zócalos esenciales.
Elige tu estilo. Sé creativo.



1. SX118 p.93 | 2. P4020 p.106 | 3. P8030 p.106 | 4. C339 p.72

SQUARE



CASCADE



CONTOUR



SMALL

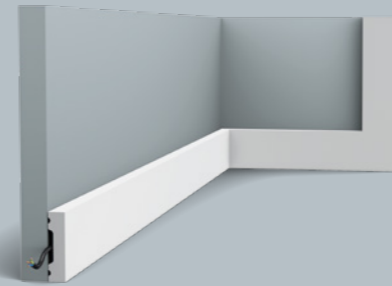

SX162 | SX162F
SQUARE
200 x 4 x 1 cm
Duropolymer®

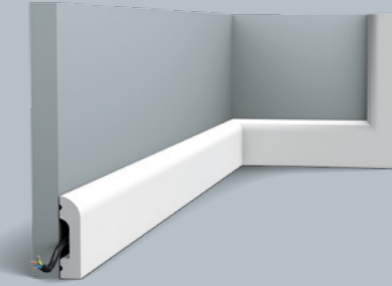

SX182 | SX182F
CASCADE
200 x 5 x 1,3 cm
Duropolymer®

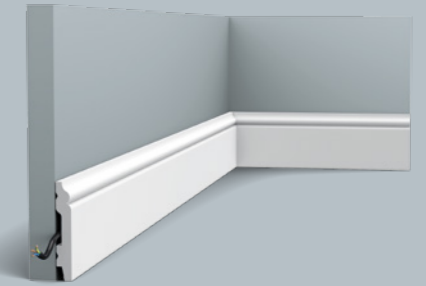

SX165 | SX165F
CONTOUR
200 x 6,9 x 1,1 cm
Duropolymer®



MEDIUM

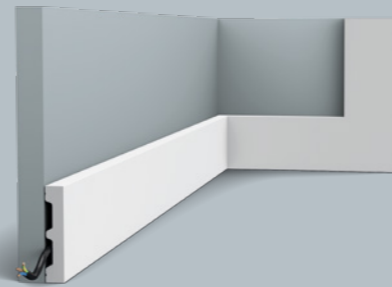

SX157 | SX157F | SX157-RAL9003
SQUARE
200 x 6,6 x 1,3 cm
Duropolymer®

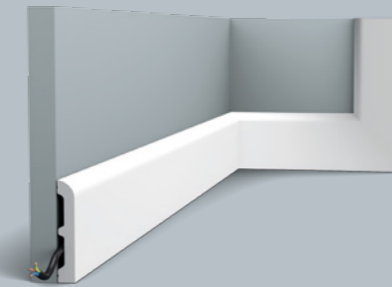

SX183 | SX183F | SX183-RAL9003
CASCADE
200 x 7,5 x 1,3 cm
Duropolymer®

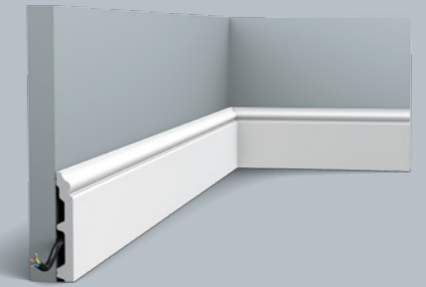

SX173 | SX173F | SX173-RAL9003
CONTOUR
200 x 10 x 1,6 cm
Duropolymer®



BIG

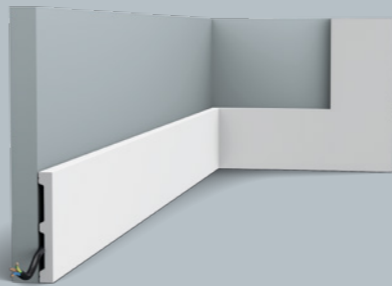

SX163 | SX163F | SX163-RAL9003
SQUARE
200 x 10,1 x 1,3 cm
Duropolymer®

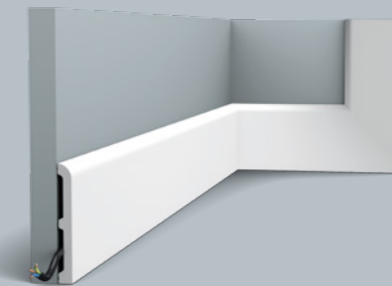

SX184 | SX184F | SX184-RAL9003
CASCADE
200 x 11 x 1,3 cm
Duropolymer®

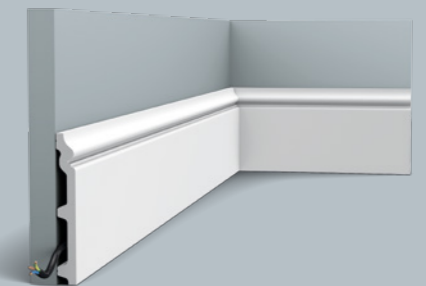

SX118 | SX118F | SX118-RAL9003
CONTOUR
200 x 13,9 x 1,8 cm
Duropolymer®



COVER

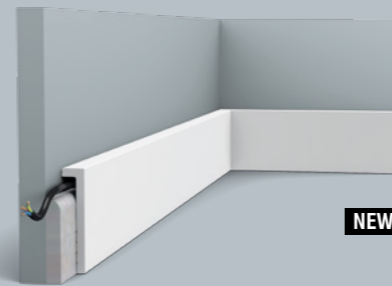

SX171 | SX171-RAL9003
SQUARE
200 x 10 x 2,2 cm
Duropolymer®

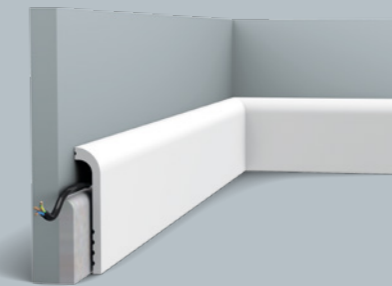

SX185
CASCADE
200 x 12 x 2,5 cm
Duropolymer®

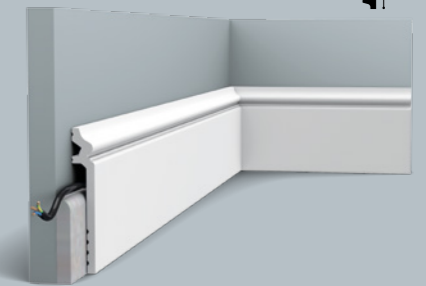

SX186
CONTOUR
200 x 13,8 x 2,2 cm
Duropolymer®





1. SX193 p.94 | 2. W120 p.126

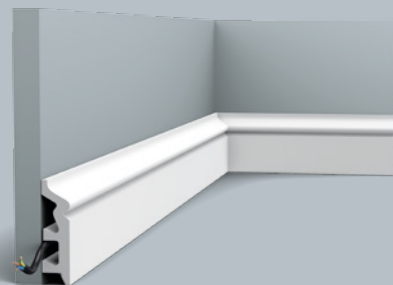

SX122
200 x 7,9 x 2,2 cm
Duropolymer®

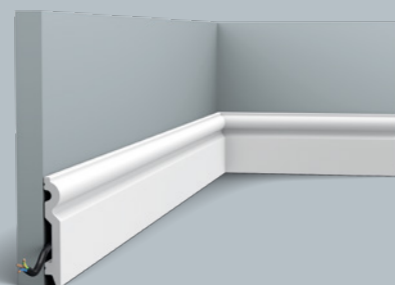

SX137 | SX137F
200 x 10 x 1,5 cm
Duropolymer®

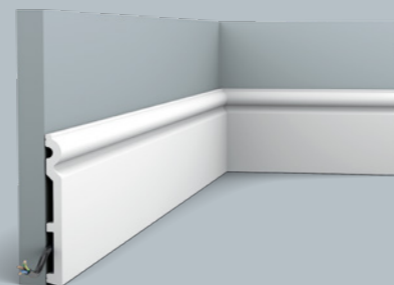

SX138 | SX138F
200 x 13,8 x 1,5 cm
Duropolymer®

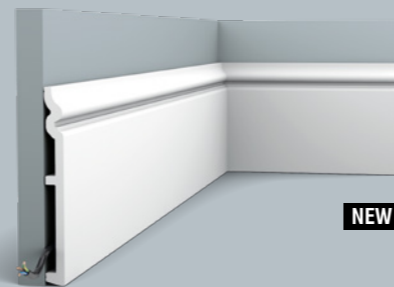

SX206 CONTOUR
200 x 18 x 1,8 cm
Duropolymer®

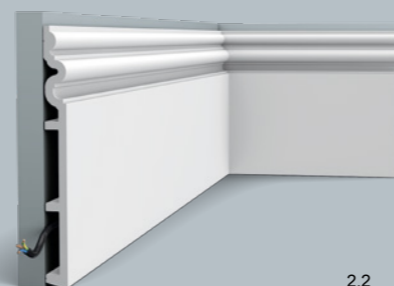

1 SX193 AUTOIRE
200 x 25 x 2,2 cm
Duropolymer®
Designed by
Orio Tonini

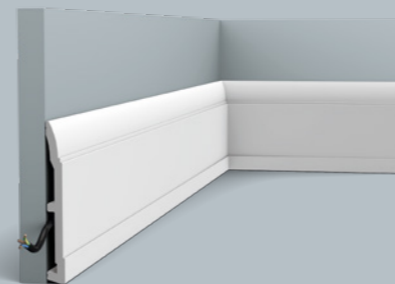

SX104 | SX104F
200 x 15 x 1,8 cm
Duropolymer®



SX156 HIGH HEELS
200 x 20,2 x 1,6 cm
Duropolymer®
Designed by
Xavier Donck



3 SX191 HIGH RISE
200 x 21 x 2,1 cm
Duropolymer®



3. SX191 p.95 | 4. PX175 p.111 | 5. DX174-2300 p.110 | 6. DX170-2300 p.150



1. SX195 p.96 | 2. P8030 p.106 | 3. W113 p.122

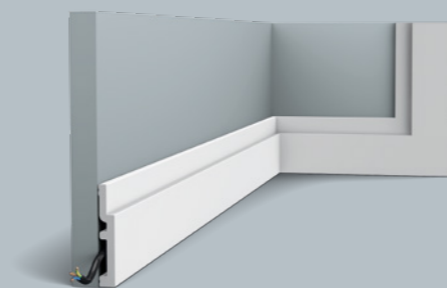

SX187 | SX187F HIGH LINE
200 x 7,5 x 1,2 cm
Duropolymer[®]
Designed by
Pierre Daems

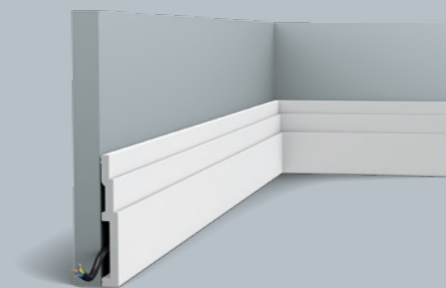

4 SX180 | SX180F HIGH LINE
200 x 12 x 1,6 cm
Duropolymer[®]
Designed by
Pierre Daems

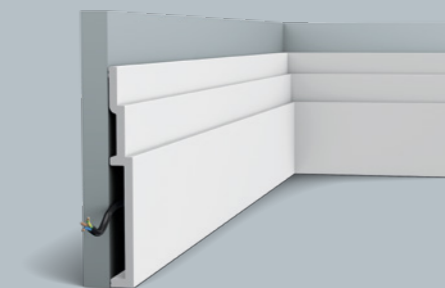

SX181 HIGH LINE
200 x 20 x 2,2 cm
Duropolymer[®]
Designed by
Pierre Daems

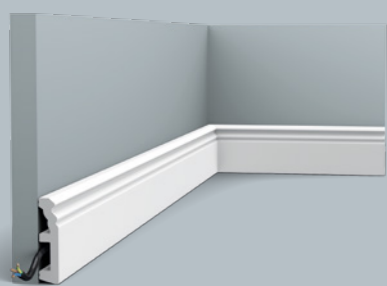

1 SX195 | SX195F HAMBURG
200 x 8 x 1,9 cm
Duropolymer[®]

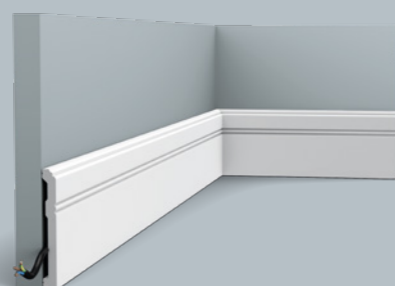

SX105 | SX105F
200 x 11 x 1,3 cm
Duropolymer[®]

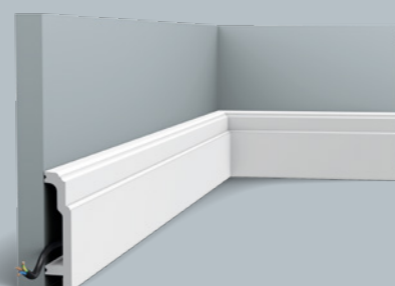

SX155 | SX155F
200 x 10,8 x 2,5 cm
Duropolymer[®]



4. SX180F p.97

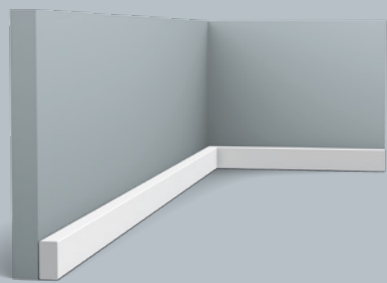

SX194 | SX194F SQUARE
200 x 2 x 1 cm
Duropolymer®

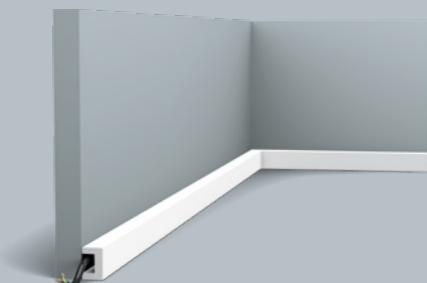

1 CX190 | CX190F U-PROFILE
200 x 3 x 2 cm
Duropolymer®
Designed by
Orio Tonini

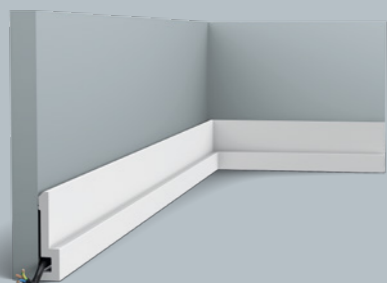

PX198 | PX198F U-STEPS
200 x 8,3 x 2 cm
Duropolymer®
Designed by
Orio Tonini

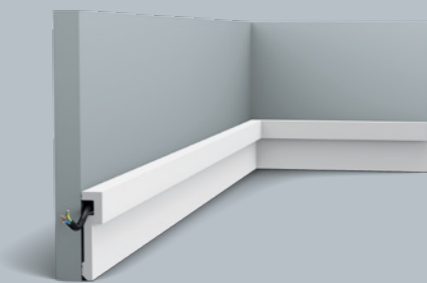

PX198 | PX198F U-STEPS
200 x 8,3 x 2 cm
Duropolymer®
Designed by
Orio Tonini

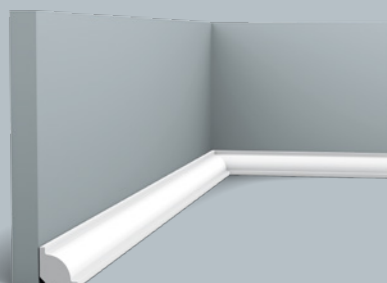

CX132 | CX132F
200 x 2 x 2 cm
Duropolymer®

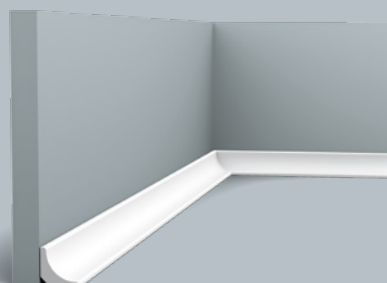

CX133
200 x 2 x 2 cm
Duropolymer®

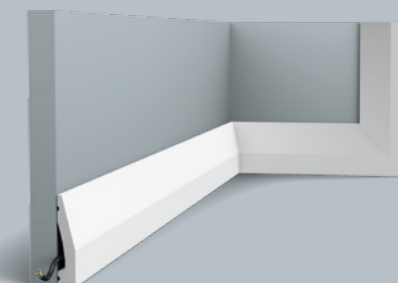

SX159
200 x 6 x 1,2 cm
Duropolymer®

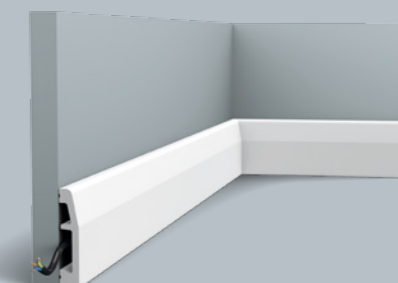
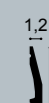

SX125
200 x 6,9 x 1,4 cm
Duropolymer®

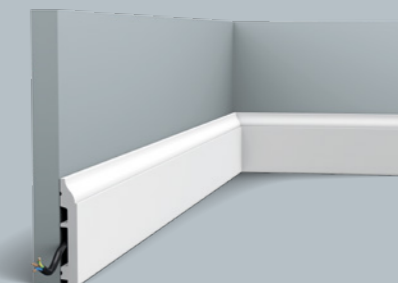

SX172 | SX172F
200 x 8,5 x 1,4 cm
Duropolymer®

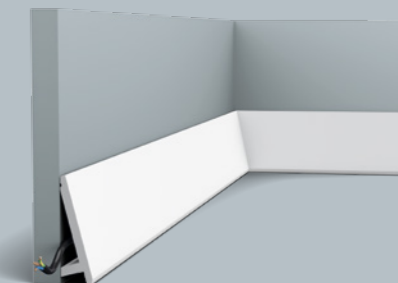

SX179 DIAGONAL
200 x 9,7 x 2,9 cm
Duropolymer®
Designed by
Orio Tonini

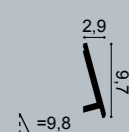

Cover Skirting Boards

OVERZETPLINTEN / SURPLINTHES
ABDECK-SOCKELLEISTEN / CUBRE RODAPIÉ

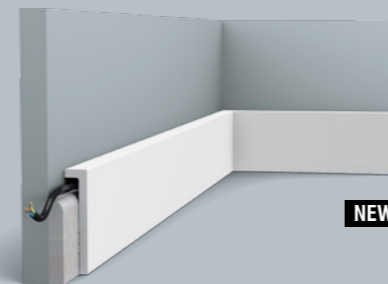

SX171 | SX171-RAL9003
SQUARE
200 x 10 x 2,2 cm
Duropolymer[®]

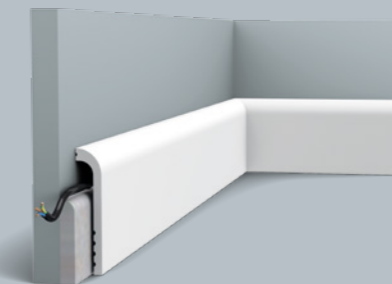
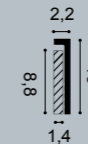

5 SX185 CASCADE
200 x 12 x 2,5 cm
Duropolymer[®]

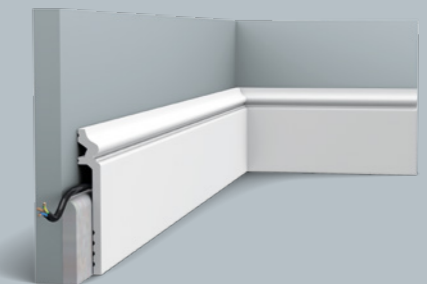
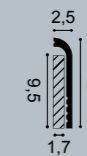

SX186 CONTOUR
200 x 13,8 x 2,2 cm
Duropolymer[®]

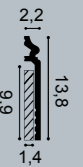

PAINTABLE
Overschilderbaar
Peut être peint
Überstreichbar
Fácil de pintar

WATER RESISTANT
Waterbestendig
Résistant à l'eau
Wasserfest
Resistente al agua

IDEAL FOR RENOVATIONS
Ideaal voor renovatie
Idéal pour des rénovations
Ideal für die Renovierung
Ideal para renovaciones



5. SX185 p.101 | 6. PX175 p.111

Multifunctional

MULTIFUNCTIONEEL / MULTIFUNCTIONNEL
MULTIFUNKTIONAL / MULTIFUNCIONAL

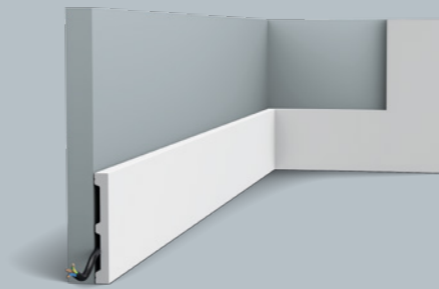

SX163 | SX163F SQUARE
200 x 10,1 x 1,3 cm
Duropolymer®

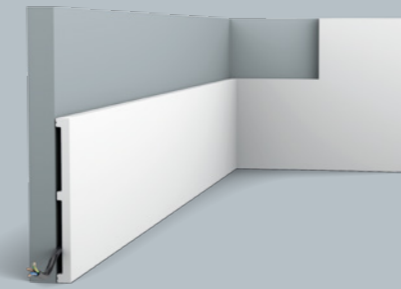

SX168 SQUARE
200 x 15 x 1,3 cm
Duropolymer®

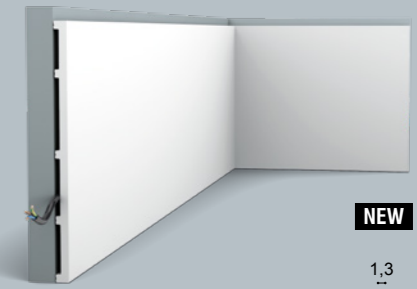

SX207 SQUARE
200 x 25 x 1,3 cm
Duropolymer®

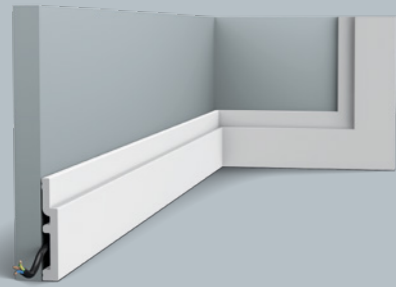

SX187 | SX187F HIGH LINE
200 x 7,5 x 1,2 cm
Duropolymer®

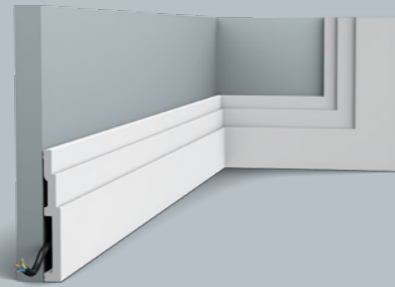

SX180 | SX180F HIGH LINE
200 x 12 x 1,6 cm
Duropolymer®

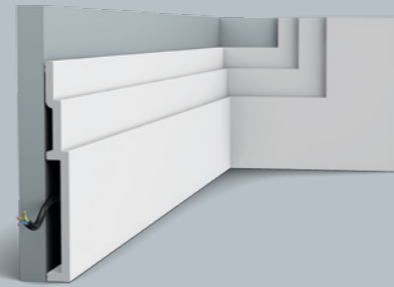

SX181 HIGH LINE
200 x 20 x 2,2 cm
Duropolymer®

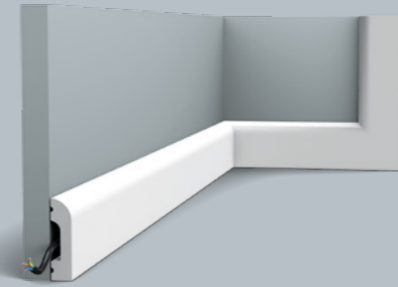

SX182 | SX182F CASCADE
200 x 5 x 1,3 cm
Duropolymer®

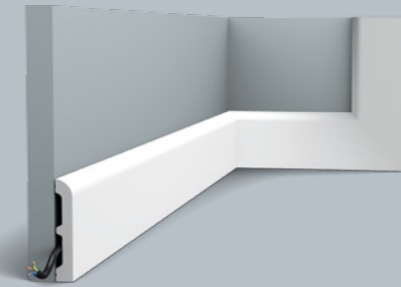

SX183 | SX183F CASCADE
200 x 7,5 x 1,3 cm
Duropolymer®

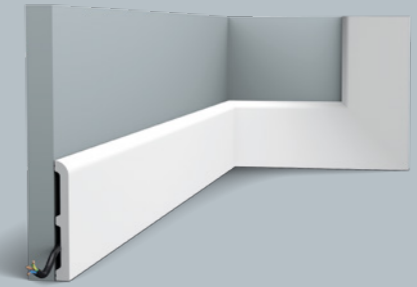

SX184 | SX184F CASCADE
200 x 11 x 1,3 cm
Duropolymer®

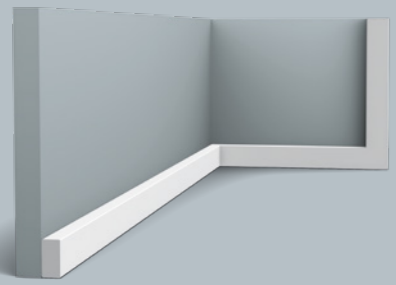
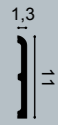

SX194 | SX194F SQUARE
200 x 2 x 1 cm
Duropolymer®

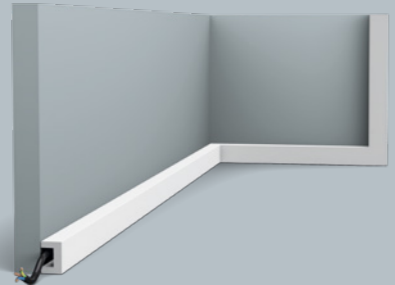

CX190 | CX190F U-PROFILE
200 x 3 x 2 cm
Duropolymer®

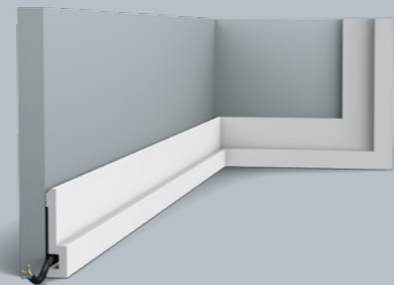

PX198 | PX198F U-STEPS
200 x 8,3 x 2 cm
Duropolymer®

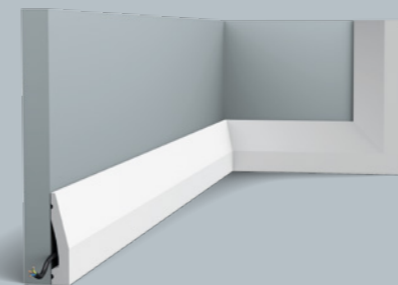

SX159
200 x 6 x 1,2 cm
Duropolymer®

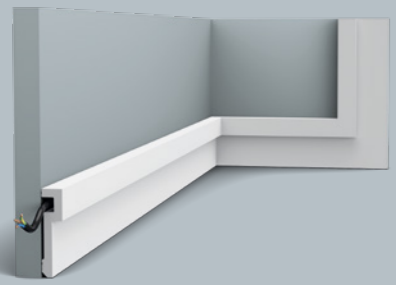

PX198 | PX198F U-STEPS
200 x 8,3 x 2 cm
Duropolymer®

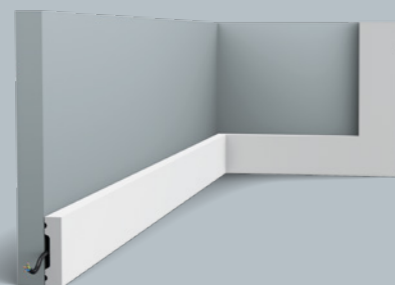

SX162 | SX162F SQUARE
200 x 4 x 1 cm
Duropolymer®

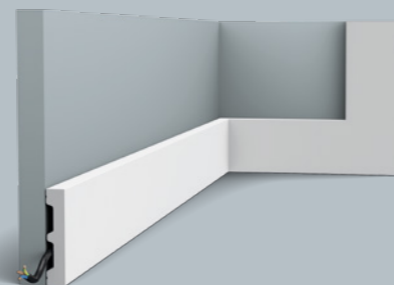

SX157 | SX157F SQUARE
200 x 6,6 x 1,3 cm
Duropolymer®



en —

Profiles with endless possibilities. Each element can be used as a panel moulding, cornice moulding, door surround or as skirting board.

nl —

Profielen met oneindig veel mogelijkheden. Één en hetzelfde profiel kan zowel als wand-, kroonlijst, deuromlijsting of plint gebruikt worden.

fr —

Des profils avec des possibilités illimitées. Un même profil peut être utilisé comme décoration murale: comme encadrement de porte, corniche, cimaise ou comme plinthe.

de —

Profil mit unzähligen Möglichkeiten. Das gleiche Element kann als Wandleiste, Eckleiste, Türumrandung oder Sockelleiste verwendet werden.

es —

Molduras con un sinfín de posibilidades. El mismo y único elemento se puede utilizar como moldura, cornisa, marco para puertas o como zócalo.



1. SX105 p.96 | 2. SX163 p.102



The Perfect Finish
PG. 154 -155



Panel Mouldings

WANDLIJSTEN / CIMAISES
WAND - UND FRIESLEISTEN / MOLDURAS



en —

Make your walls come to life by "wallscaping" them with panel mouldings. Integrating indirect lighting, visually changing ceiling height, adding character and bringing symmetry, our panel mouldings are the ideal addition to your home.

nl —

Laat je muren tot leven komen door wandarchitectuur te maken met wandlijsten. Ze integreren indirecte verlichting, veranderen plafondhoogte visueel, voegen karakter toe en brengen symmetrie. Onze wandlijsten zijn de perfecte aanvulling voor je huis.

fr —

Donnez vie à vos murs en les « sculptant » avec des cimaises. Intégrant un éclairage indirect, changeant visuellement la hauteur du plafond, ajoutant du caractère et apportant une symétrie, nos cimaises constituent le complément idéal à votre maison.

de —

Erwecken Sie Ihre Wände zum Leben, indem Sie sie mit Wandleisten „tapezieren“. Mit unseren Wand- und Friesleisten können Sie eine indirekte Beleuchtung hinzufügen, die Deckenhöhe optisch erhöhen und einer Wand mehr Symmetrie verleihen. Sie passen wunderbar in Ihr Zuhause.

es —

Llena de vida tus paredes y realiza preciosos montajes con nuestras molduras. Integra iluminación indirecta y cambiará visualmente la altura del techo, añadirá carácter y aportará simetría, nuestras molduras se convierten en el complemento ideal para tu hogar.

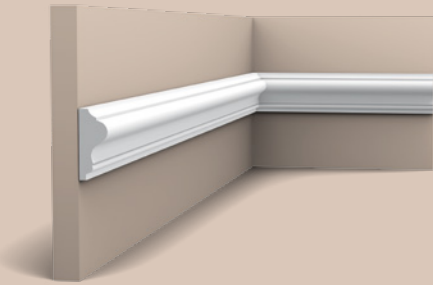

2 P8030 | P8030F
200 x 4,1 x 1,7 cm
Purotouch®

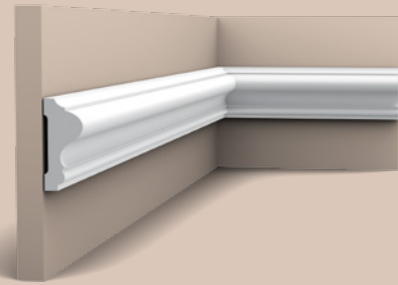

P8020 | P8020F
200 x 6 x 2,6 cm
Purotouch®

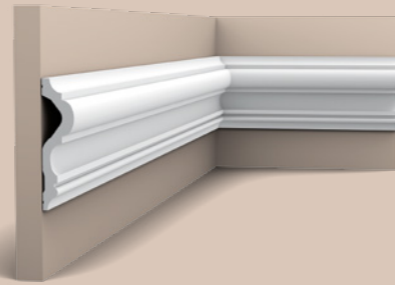

P8050 | P8050F
200 x 12 x 3 cm
Purotouch®

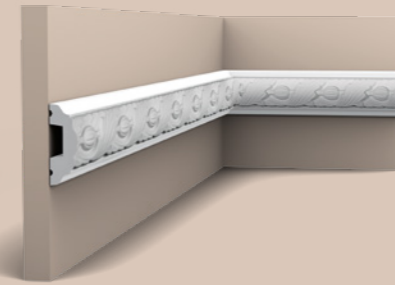

P1020
200 x 4,9 x 2,4 cm
Purotouch®

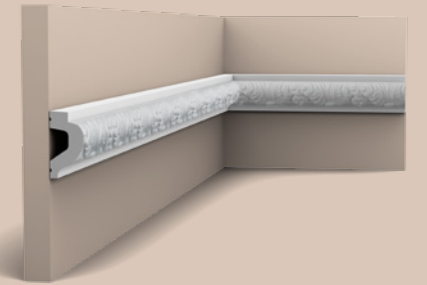

P3020 | P3020F
200 x 6,1 x 3,2 cm
Purotouch®

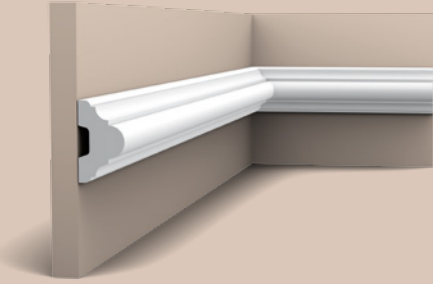

P4020 | P4020F
200 x 5 x 2,9 cm
Purotouch®

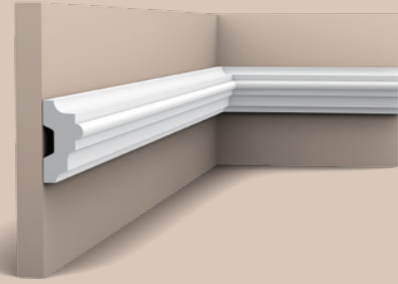

P9040
200 x 5 x 2,5 cm
Purotouch®

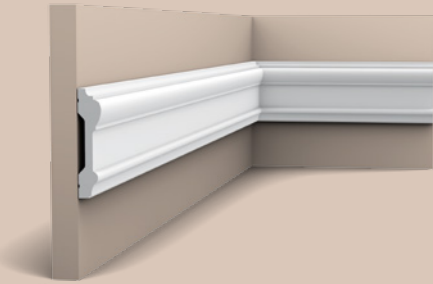

P9010 | P9010F
200 x 9,1 x 3 cm
Purotouch®

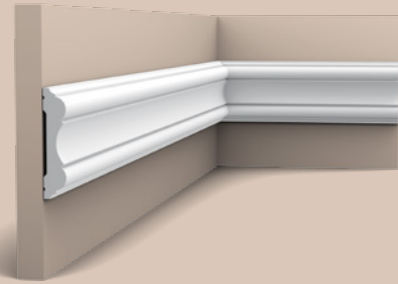

P8040 | P8040F
200 x 10,1 x 2,2 cm
Purotouch®

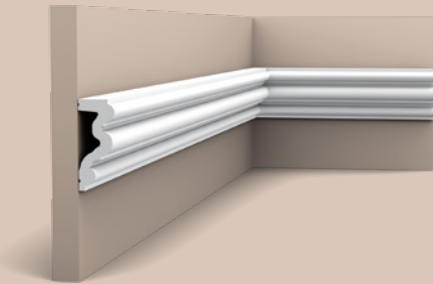

P4025 | P4025F AUTOIRE
200 x 8,3 x 3,4 cm
Purotouch®
Designed by
Orio Tonini

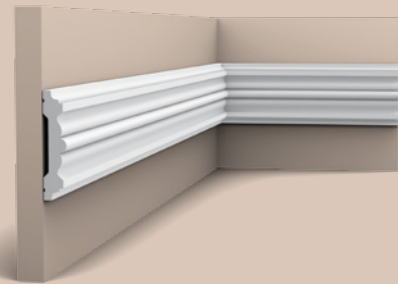
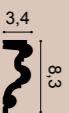

P9020
200 x 9,6 x 2,1 cm
Purotouch®

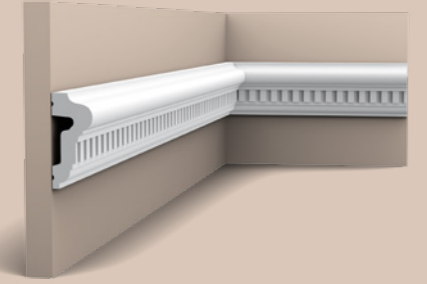

P6020
200 x 6,4 x 2,8 cm
Purotouch®

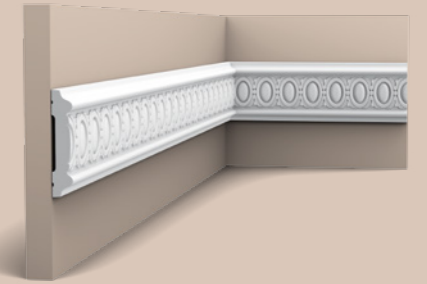
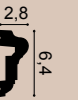

P7030
200 x 8,5 x 1,7 cm
Purotouch®

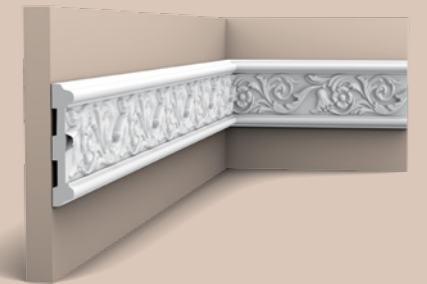

P7020
200 x 11,1 x 1,9 cm
Purotouch®



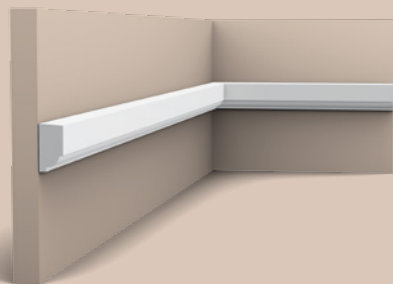

P9050 | P9050F
200 x 2,5 x 1,3 cm
Purotouch[®]

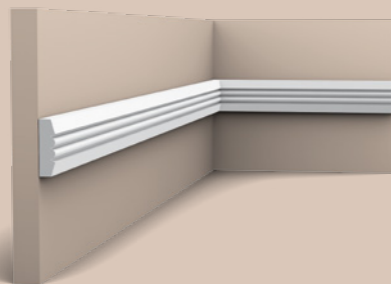

P5021 | P5021F
200 x 3,1 x 0,9 cm
Purotouch[®]

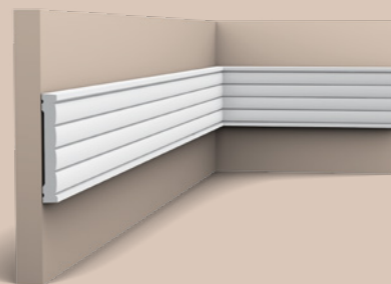

P5020
200 x 9,1 x 1,3 cm
Purotouch[®]

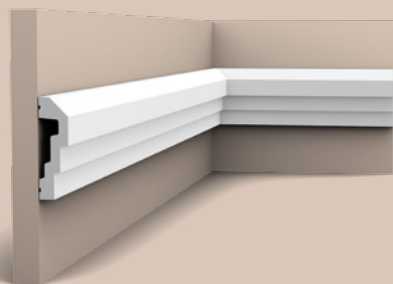

P7070 | P7070F
200 x 7,4 x 2,2 cm
Purotouch[®]

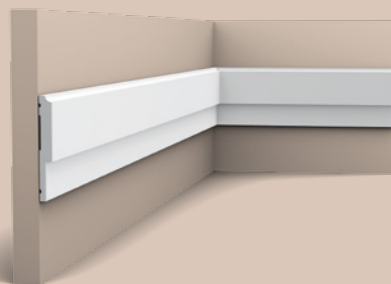

P9900 | P9900F
200 x 8 x 1 cm
Purotouch[®]

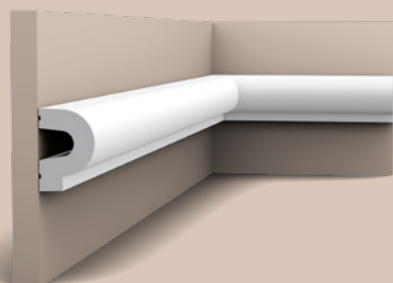

P8060
200 x 5 x 3,5 cm
Purotouch[®]

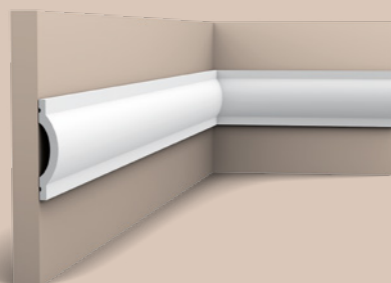

P9901
200 x 7 x 1,4 cm
Purotouch[®]

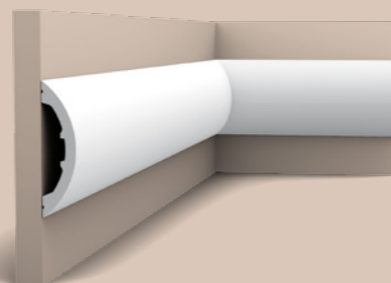

P3070 RADIUS
200 x 12,5 x 3,2 cm
Purotouch[®]
Designed by
Ulf Moritz

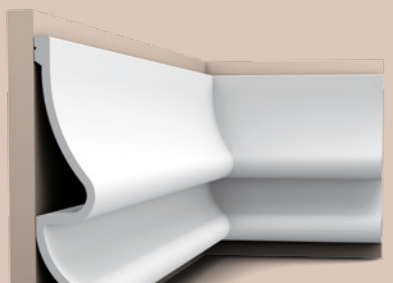

P3071 GOLF
200 x 37,2 x 7,6 cm
Purotouch[®]
Designed by
Ulf Moritz



1. P3071 p.108

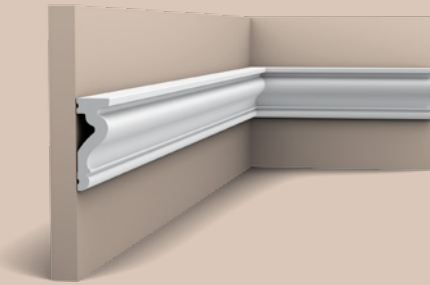

2 DX174-2300 | DX174F
230 x 6 x 2,2 cm (DX174-2300)
Duropolymer®
200 x 6 x 2,2 cm (DX174F)

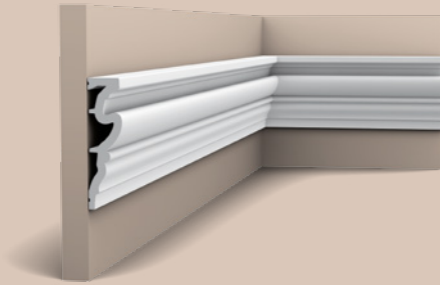

DX170-2300
230 x 11,9 x 3,2 cm
Duropolymer®

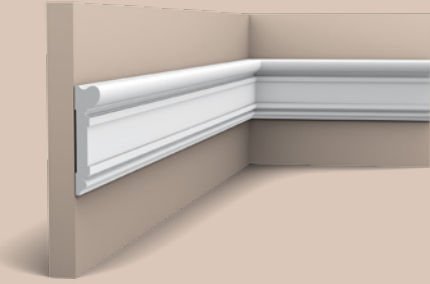

DX119-2300
230 x 9,2 x 2,2 cm
Duropolymer®

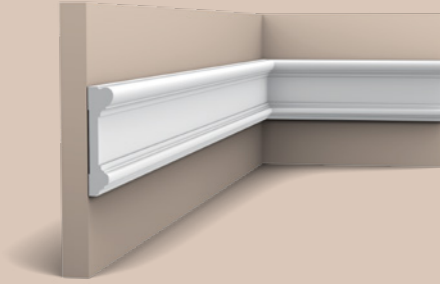

DX121-2300
230 x 9,4 x 2,3 cm
Duropolymer®

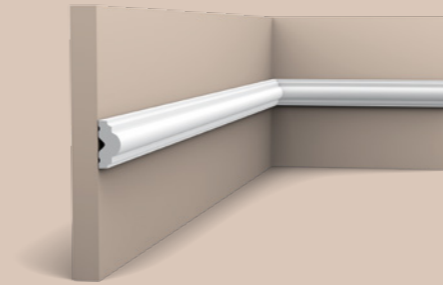

PX103 | PX103F
200 x 2,5 x 1,2 cm
Duropolymer®

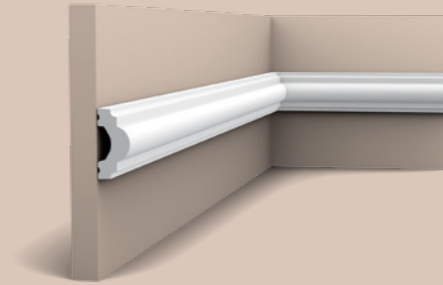

PX120 | PX120F
200 x 4 x 1,9 cm
Duropolymer®

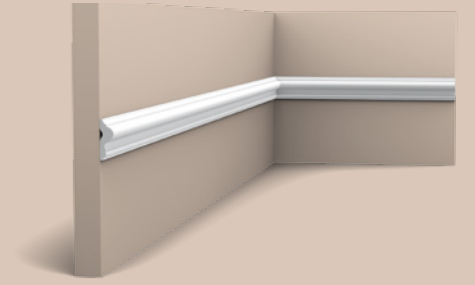

PX201 | PX201F
200 x 2,5 x 0,9 cm
Duropolymer®

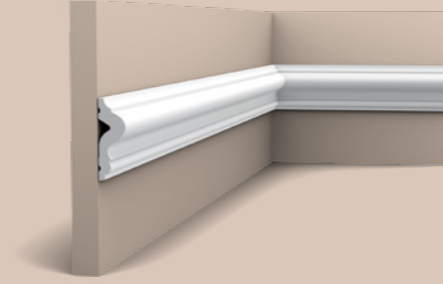

PX175 | PX175F
200 x 5 x 1,7 cm
Duropolymer®

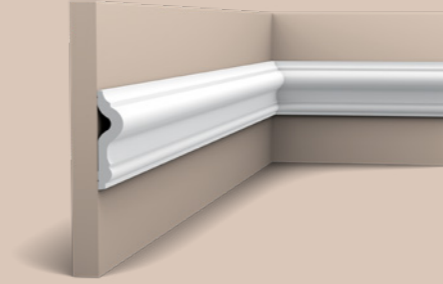

PX202 | PX202F
200 x 7,5 x 2 cm
Duropolymer®

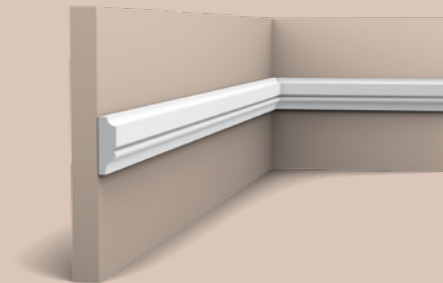

PX116
200 x 3,1 x 1 cm
Duropolymer®

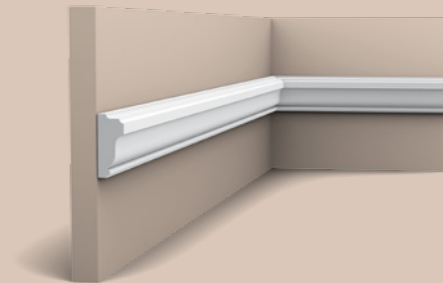

PX117
200 x 3,5 x 1,5 cm
Duropolymer®

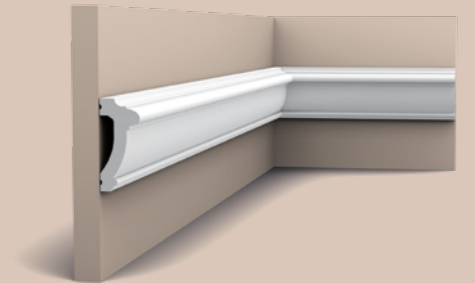

PX113
200 x 6 x 2,7 cm
Duropolymer®

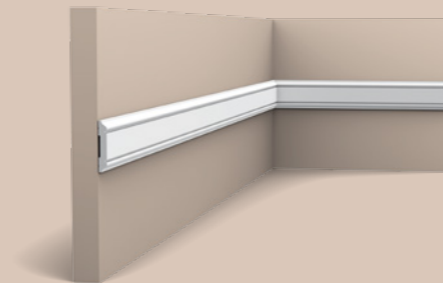

PX144 | PX144F
200 x 4,7 x 0,8 cm
Duropolymer®

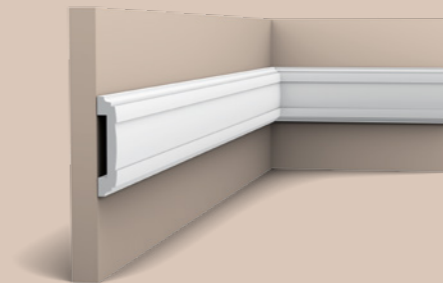

PX102
200 x 7,9 x 1,6 cm
Duropolymer®

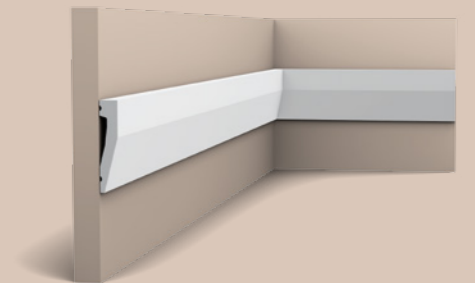

SX159
200 x 6 x 1,2 cm
Duropolymer®



1. SX191 p.95 | 2. DX174-2300 p.110 | 3. W130 p.120

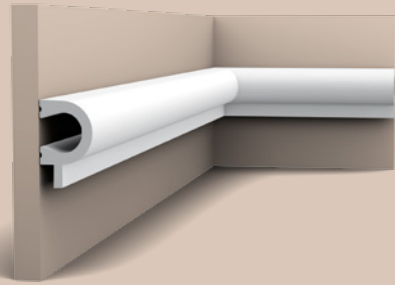

PX169 A
200 x 5,5 x 3,4 cm
Duropolymer[®]

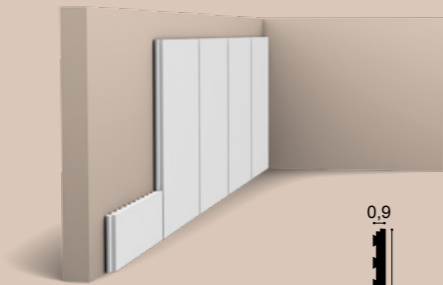

PX147 B
200 x 16,9 x 0,9 cm
Duropolymer[®]

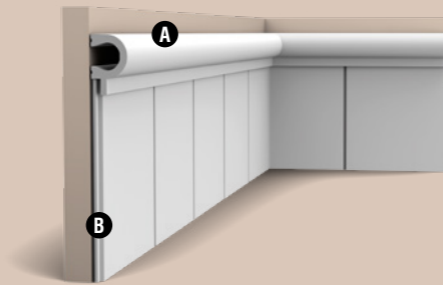

PX169 + PX147

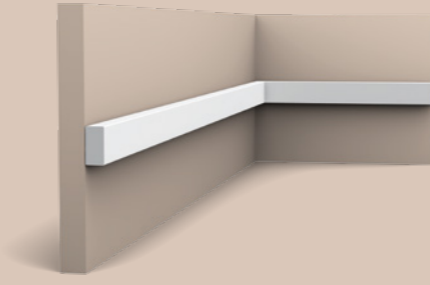

SX194 | SX194F SQUARE
200 x 2 x 1 cm
Duropolymer[®]

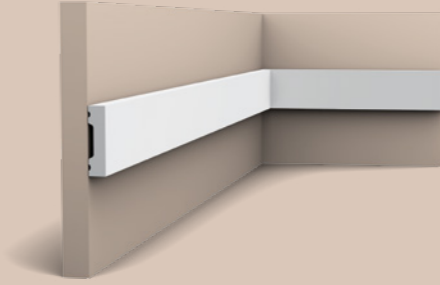

SX162 | SX162F SQUARE
200 x 4 x 1 cm
Duropolymer[®]

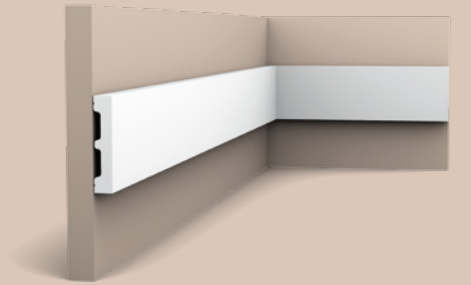

SX157 | SX157F SQUARE
200 x 6,6 x 1,3 cm
Duropolymer[®]



2

1

1. P8020 p.106 | 2. P4020 p.106

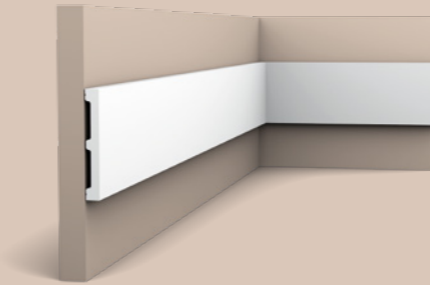

SX163 | SX163F SQUARE
200 x 10,1 x 1,3 cm
Duropolymer[®]

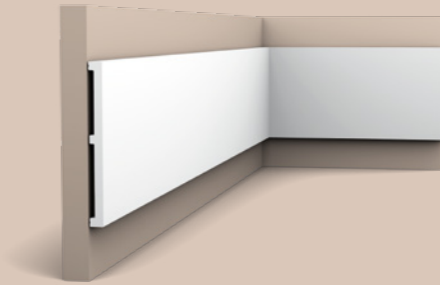

SX168 SQUARE
200 x 15 x 1,3 cm
Duropolymer[®]

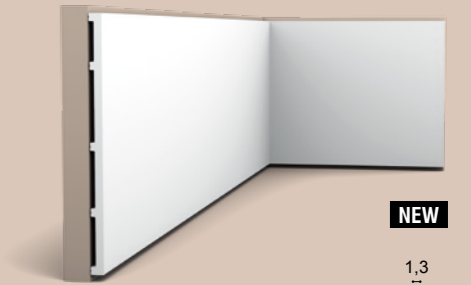

SX207 SQUARE
200 x 25 x 1,3 cm
Duropolymer[®]

NEW

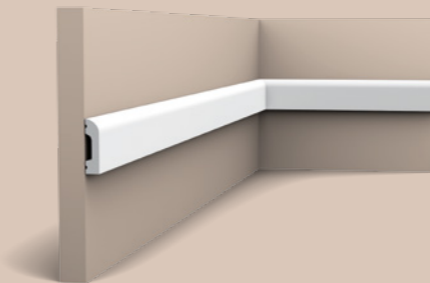

SX182 | SX182F CASCADE
200 x 5 x 1,3 cm
Duropolymer[®]

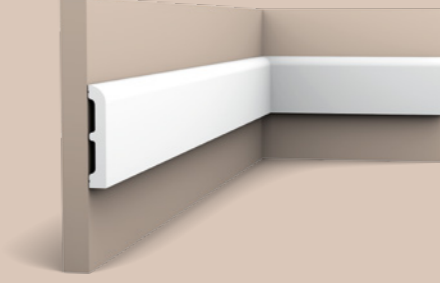

SX183 | SX183F CASCADE
200 x 7,5 x 1,3 cm
Duropolymer[®]

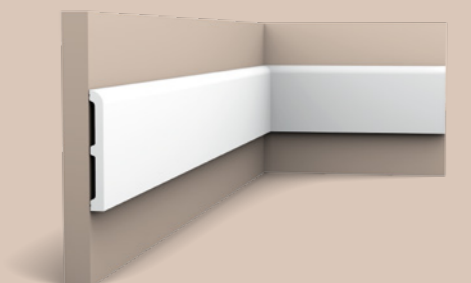

SX184 | SX184F CASCADE
200 x 11 x 1,3 cm
Duropolymer[®]

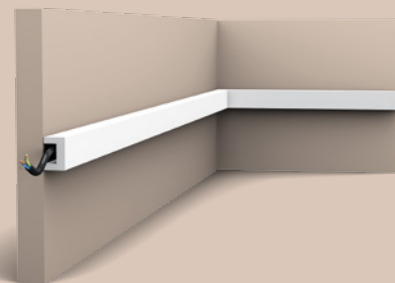
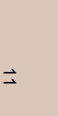

CX190 | CX190F U-PROFILE
200 x 3 x 2 cm
Duropolymer[®]
Designed by
Orio Tonini

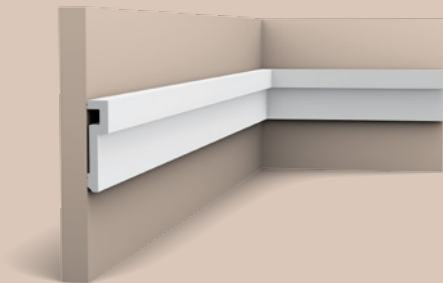

PX198 | PX198F U-STEPS
200 x 8,3 x 2 cm
Duropolymer[®]
Designed by
Orio Tonini

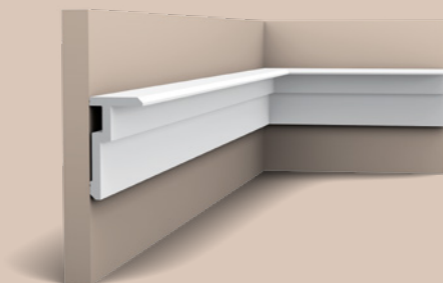

CX197 U-STEPS
200 x 9,3 x 5 cm
Duropolymer[®]
Designed by
Orio Tonini

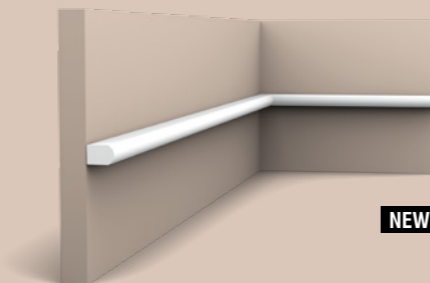

PX209 | PX209F RIBBON
200 x 1 x 1,8 cm
Duropolymer[®]
Designed by
Orio Tonini

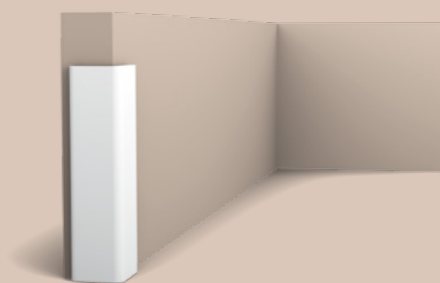

CX134
200 x 3 x 3 cm
Duropolymer[®]





1. PX120 p.111 | 2. SX156 p.95 | 3. P3020A p.115 | 4. P3020 p.107

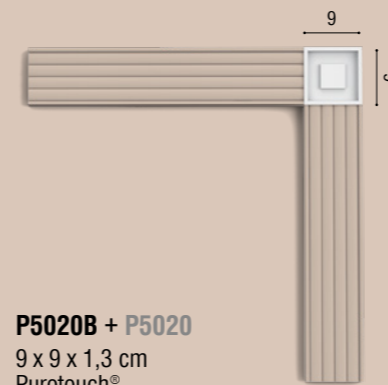

P5020B + P5020
9 x 9 x 1,3 cm
Purotouch®

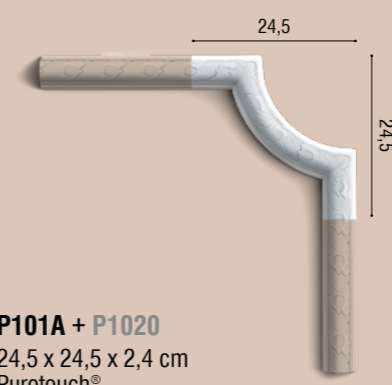

P101A + P1020
24,5 x 24,5 x 2,4 cm
Purotouch®



P801C + P8020
19,8 x 11 x 2,6 cm
Purotouch®



P4020A + P4020
16,4 x 9,1 x 2,9 cm
Purotouch®



3 P3020A + P3020
42,5 x 42,5 x 4 cm
Purotouch®

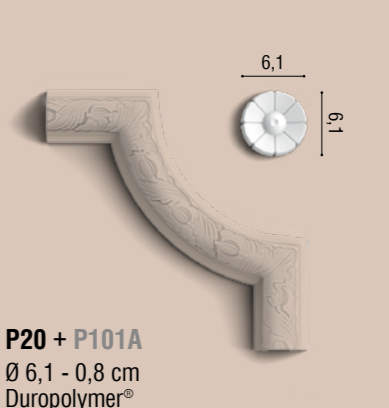

P20 + P101A
Ø 6,1 - 0,8 cm
Duropolymer®



PX103A + PX103
19 x 3,5 x 1,5 cm
Duropolymer®

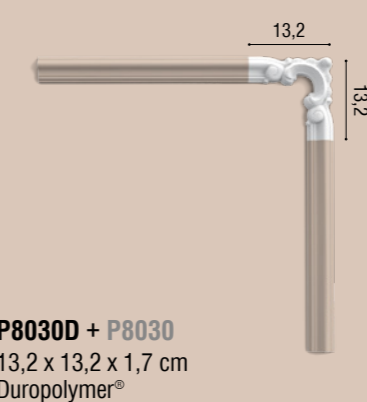

P8030D + P8030
13,2 x 13,2 x 1,7 cm
Duropolymer®



P8030C + P8030
19 x 8,6 x 1,7 cm
Duropolymer®

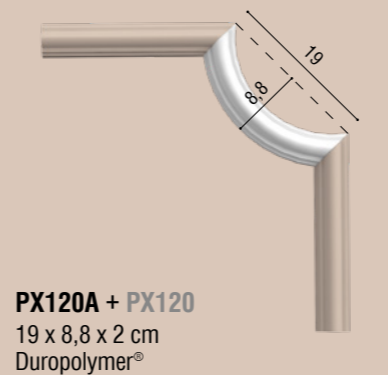

PX120A + PX120
19 x 8,8 x 2 cm
Duropolymer®



3D Wall Covering

3D WANDBEKLEDING / REVÊTEMENTS MURAUX 3D
3D WANDVERTÄFELUNG
REVESTIMIENTO DE PARED 3D



en —

Modern and contemporary. Bold and outspoken. Textured and fascinating. What inspires you and your walls? Create an immediate wow effect with our 3D Wall Covering. From large 3D panels to classic shapes, we have a range of eye-catching styles for every home.

nl —

Modern en hedendaags. Gewaagd en uitgesproken. Getextureerd en fascinerend. Wat inspireert jou en je muren? Zorg voor een onmiddellijk wow-effect met onze 3D Wall Covering. Van grote 3D panelen tot klassieke vormen, we hebben een hele waaier aan oogverblindende stijlen voor elke thuis.

fr —

Modernes et contemporains. Audacieux et prononcé. Texturés et fascinants. Qu'est-ce qui vous inspire, vous et vos murs ? Créez un effet éblouissant immédiat avec notre revêtement mural 3D. Des grands panneaux 3D aux formes classiques, nous avons une gamme de styles attrayants pour chaque maison.

de —

Modern und zeitgemäß. Kühn und prägnant. Strukturiert und faszinierend. Was inspiriert Sie und Ihre Wände? Mit unserer 3-D-Wandverkleidung sorgen Sie einen sofortigen Wow-Effekt. Von großen 3-D-Paneelen bis zu klassischen Formen – wir bieten eine Auswahl an auffälligen Styles für jedes Zuhause.

es —

Moderno y contemporáneo. Atrevido y sin palabras. Con textura y exclusivo. ¿Qué te inspira a ti y a tus paredes? Consigue un efecto sorpresa inmediato con nuestros revestimientos 3D. Desde grandes paneles 3D hasta formas clásicas, tenemos una gama de estilos atractivos para cada hogar.



W108 | W108F ZIGZAG

200 x 25 x 1,8 cm
Purotouch[®]
Designed by
Orio Tonini



W108 ZIGZAG + 2x CX190

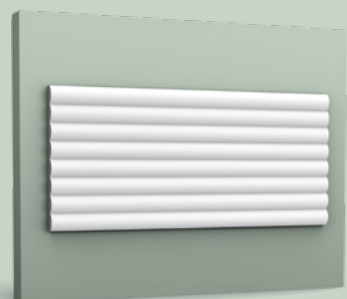

W110 | W110F HILL

200 x 25 x 1,6 cm
Purotouch[®]
Designed by
Orio Tonini



W110 HILL + 2x CX190



3. SX118 p.93 | 4. PX209 p.113 | 5. W109 p.119 | 6. W212 p.119 | 7. SX168 p.103

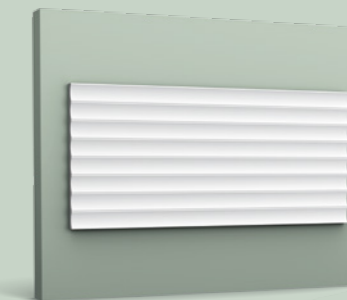

W109 | W109F VALLEY

200 x 25 x 1,2 cm
Purotouch[®]
Designed by
Orio Tonini



W109 VALLEY + 2x CX190



1. W110 p.118 | 2. CX190F p.138



W114 | W114F VALLEY XL

200 x 25 x 1,5 cm
Purotouch[®]
Designed by
Orio Tonini



W114 + 2x SX194

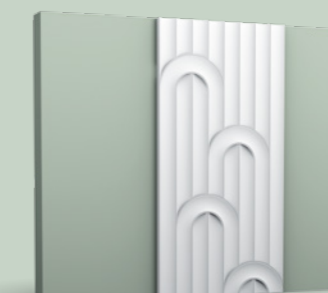

W212 VALLEY LOOP

200 x 25 x 1,2 cm
Purotouch[®]
Designed by
Orio Tonini



W212 + 2x PX209

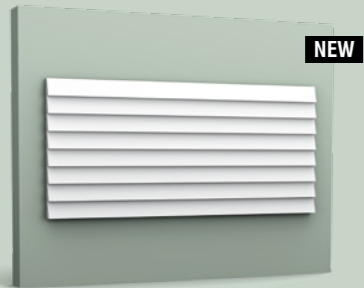

NEW

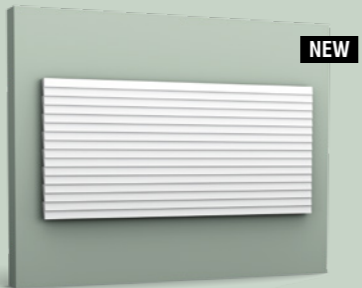

NEW

WX204 | WX204-2600 RIPPLE

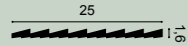

200 x 25 x 1,6 cm
260 x 25 x 1,6 cm
Duopolymer®

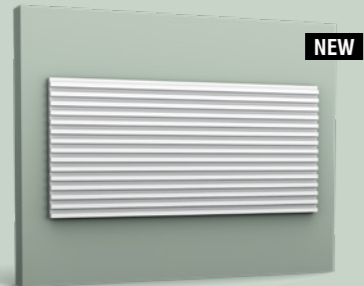
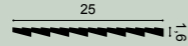

NEW

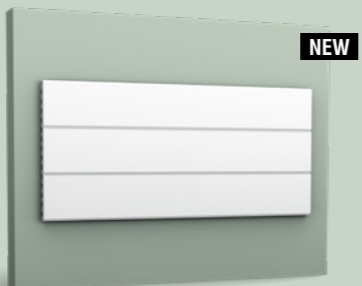

NEW

WX205 | WX205-2600 TRACK

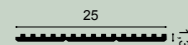

200 x 25 x 1,3 cm
260 x 25 x 1,3 cm
Duopolymer®

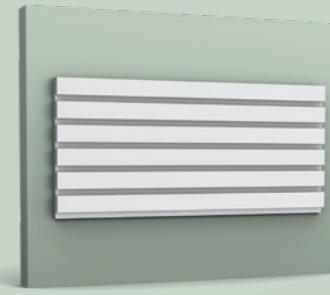
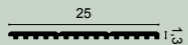

5 7 W111 | W111F BAR

200 x 25 x 2 cm
Purotouch®
Designed by
Orio Tonini

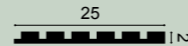

W111 + CX190 + PX198



6 9 W116 | W116F BAR XL

200 x 25 x 2 cm
Purotouch®
Designed by
Orio Tonini

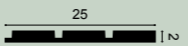

W111 + CX190 + PX198



NEW

4 8 W119 | W119F BAR MIX

200 x 25 x 2 cm
Purotouch®
Designed by
Orio Tonini

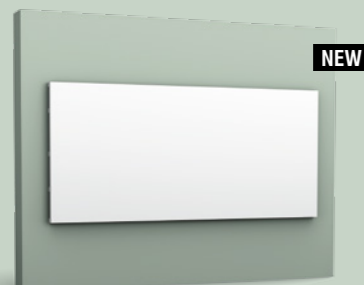
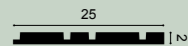

NEW

SX207 SQUARE
200 x 25 x 1,3 cm
Duopolymer®

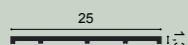

1. SX194 p.98 | 2. WX204 p.98 | 3. CX190 p.139



4. W119F p.121 | 5. W111F p.121 | 6. W116F p.121 | 7. W111 p.121 | 8. W119 p.121 | 9. W116 p.121 | 10. PX198F p.112 | 11. CX190F p.139

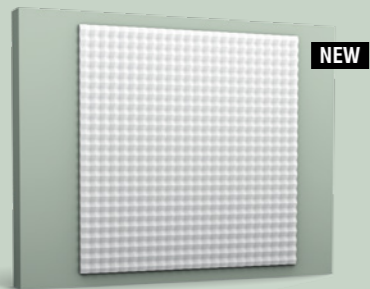

W117 SLOPE
100 x 100 x 2,3 cm
Purotouch®
Designed by
Orio Tonini

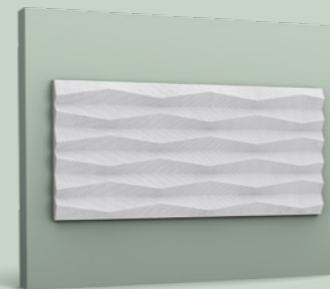

W112 RIDGE
200 x 25 x 1,9 cm
Purotouch®
Designed by
Orio Tonini

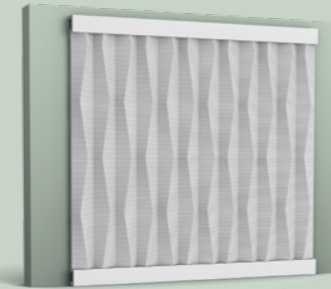
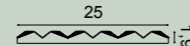

W112 + 2x CX190

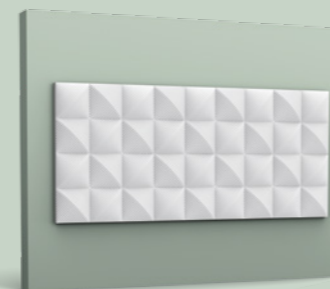

W113 COBBLE
200 x 25 x 2,2 cm
Purotouch®
Designed by
Orio Tonini

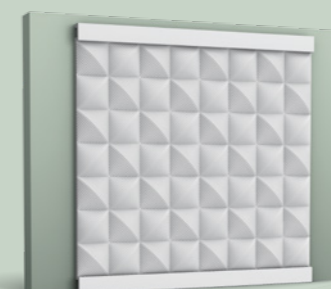
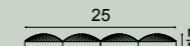

W113 + 2x CX190



W130 CHEVRON
200 x 40 x 2 cm
Purotouch®

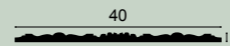

W130 + 2x CX190



1. PX198 p.98 | 2. CX190 p.112 | 3. W117 p.122 | 4. CX196 p.138



5. SX171 p.101 | 6. W112 p.122

Positive Thermal & Acoustic Effects

Purotouch®

POSITIEVE THERMISCHE EN AKOESTISCHE EFFECTEN
EFFETS THERMIQUES ET ACOUSTIQUES POSITIFS
POSITIVE THERMISCHE UND AKUSTISCHE WIRKUNG
AISLAMIENTO TÉRMICO Y ACÚSTICO

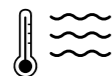

THERMAL INSULATION

Thermische isolatie | Isolation thermique
Thermische Dämmung
Aislamiento térmico

$\lambda = 0,029 \text{ W/mK} - R = 0,55 \text{ m}^2\text{K/W}$

Equals effect of insulation board
of the same thickness.

Gelijk aan het effect van isolatieplaten
van dezelfde dikte.

Avec le même effet que des panneaux isolants
de la même épaisseur.

Gleiche Wirkung wie eine Dämmplatte gleicher Stärke.

Igual efecto del tablero aislante del mismo espesor.



ACOUSTIC ABSORPTION

Akoestische absorptie | Absorption
acoustique | Schallabsorption
Absorción acústica

CLASS E

Absorbs up to 25% of a conversation.

Absorbeert tot 25% van een gesprek.

Absorbe jusqu'à 25% des conversations.

Absorbiert bis zu 25% des Raumschalls.

Absorbe hasta el 25% de una conversación.



Flex Panels

Our wall panels ZIGZAG, VALLEY (XL), HILL (XL) and BAR (XL) are now also available in a flexible version.

Onze wandpanelen ZIGZAG, VALLEY (XL), HILL (XL) en BAR zijn nu ook verkrijgbaar in een flexibele variant.

Nos panneaux muraux ZIGZAG, VALLEY (XL), HILL (XL) et BAR sont désormais également disponibles en version flexible.

Unsere Wandpaneele ZIGZAG, VALLEY (XL), HILL (XL) und BAR sind jetzt auch in einer flexiblen Version erhältlich.

Nuestros paneles de pared ZIGZAG, VALLEY (XL), HILL (XL) y BAR ahora también están disponibles en una versión flexible.

1 W108 | W108F ZIGZAG

200 x 25 x 1,8 cm
Purotouch®

Designed by
Orio Tonini

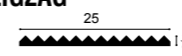

2 W109 | W109F VALLEY

200 x 25 x 1,2 cm
Purotouch®

Designed by
Orio Tonini

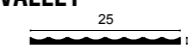

3 W110 | W110F HILL

200 x 25 x 1,6 cm
Purotouch®

Designed by
Orio Tonini

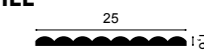

W111 | W111F BAR

200 x 25 x 2 cm
Purotouch®

Designed by
Orio Tonini

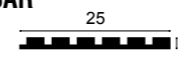

W114 | W114F VALLEY XL

200 x 25 x 1,5 cm
Purotouch®

Designed by
Orio Tonini

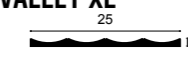

W116 | W116F BAR XL

200 x 25 x 2 cm
Purotouch®

Designed by
Orio Tonini



W119 | W119F BAR MIX

200 x 25 x 2 cm
Purotouch®

Designed by
Orio Tonini

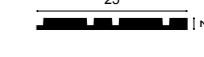

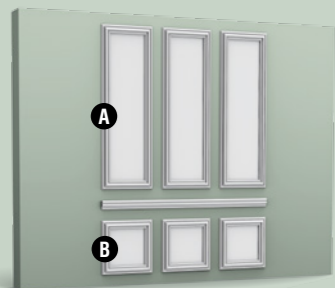

W120 + P4025 + W121
Purotouch®
Designed by
Orio Tonini

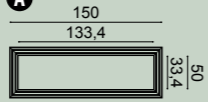
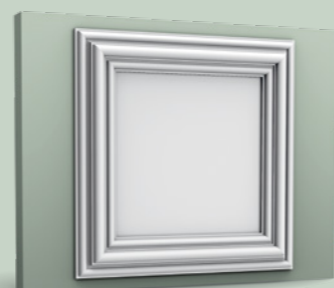

6 W120 AUTOIRE A
50 x 150 x 3,2 cm
Purotouch®
Designed by
Orio Tonini

2 W121 AUTOIRE B
50 x 50 x 3,2 cm
Purotouch®
Designed by
Orio Tonini



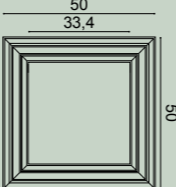
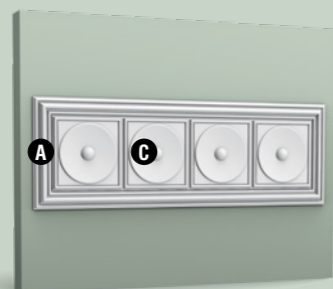

W120 + 4*W122
Purotouch®
Designed by
Orio Tonini

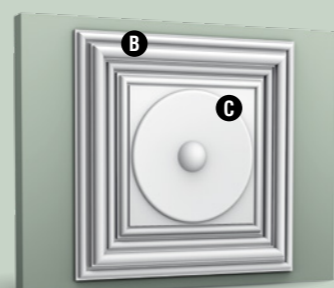

W121 + W122
Purotouch®
Designed by
Orio Tonini

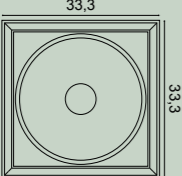
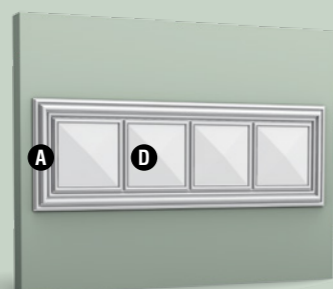
4 W122 AUTOIRE C
33,3 x 33,3 x 2,6 cm
Purotouch®
Designed by
Orio Tonini



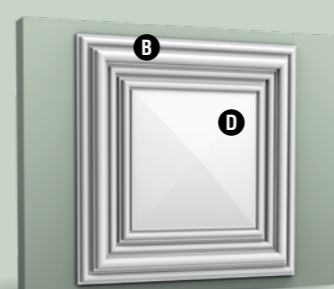

W120 + 4*W123
Purotouch®
Designed by
Orio Tonini

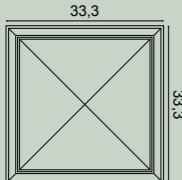
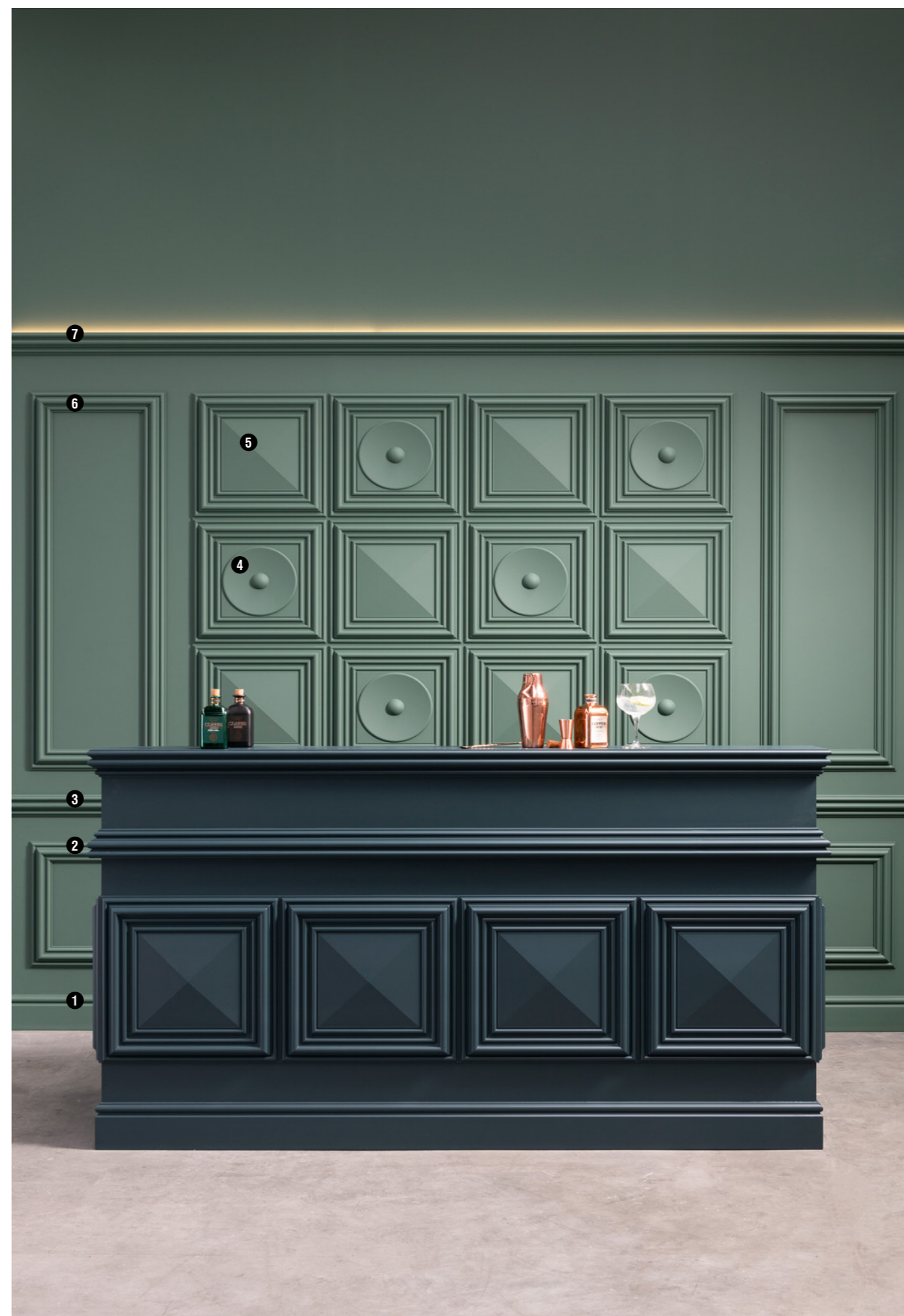

W121 + W123
Purotouch®
Designed by
Orio Tonini

5 W123 AUTOIRE D
33,3 x 33,3 x 3,5 cm
Purotouch®
Designed by
Orio Tonini

1. SX138 p.94 | 2. W121 p.126 | 3. P4020 p.106 | 4. W122 p.126 | 5. W123 p.126 | 6. W120 p.126 | 7. C324 p.132



W100 ROMBUS
25,8 x 15 x 2,9 cm
Purotouch®

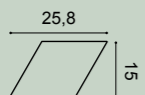

W101 TRAPEZIUM
34,5 x 15 x 2,9 cm
Purotouch®

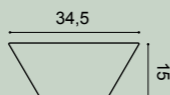

W105 ROMBUS
30 x 34,6 x 3 cm
Purotouch®

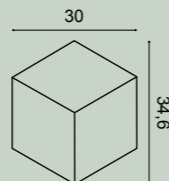

W102 CUBI
33,3 x 33,3 x 2,5 cm
Purotouch®

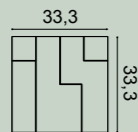

W103 CUBI
33,3 x 33,3 x 2,5 cm
Purotouch®

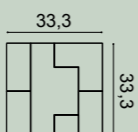

1 W106 ENVELOP
33,3 x 33,3 x 2,9 cm
Purotouch®
Designed by Orio Tonini

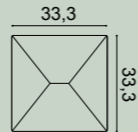

2 W107 CIRCLE
33,3 x 33,3 x 2,9 cm
Purotouch®
Designed by Orio Tonini

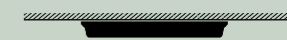
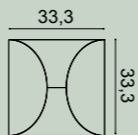

3 F30
59,5 x 59,5 x 4,3 cm
Purotouch®



1. W106 p.128 | 2. W107 p.128



3. F30 p.129



The Perfect Finish
PG. 154 - 155

Led Coving

INDIRECTE VERLICHTING / ÉCLAIRAGE INDIRECT
INDIREKTE BELEUCHTUNG / ILUMINACIÓN INDIRECTA



en —

Enhance the architecture of your room and add atmosphere with led coving solutions that match your style. From sleek to organic, uplights to downlights, linear to diffuse, our range lets you play with shadow and light to make your room look larger or cosier.

nl —

Zet de architectuur van je ruimte in de verf en voeg sfeer toe met indirecte verlichtingsoplossingen die passen bij jouw stijl. Van strak tot organisch, uplighters of downlighters, lineair of diffuus, onze collectie laat je spelen met licht en schaduw om je ruimte groter of gezelliger te doen lijken.

fr —

Soulignez l'architecture de votre pièce et ajoutez de l'ambiance avec des solutions d'éclairage indirect qui correspondent à votre style. Qu'il s'agisse de lumières simples ou organiques, de lumières vers le haut ou vers le bas, linéaires ou diffuses, notre gamme vous permet de jouer avec l'ombre et la lumière pour rendre votre pièce plus grande ou plus confortable.

de —

Mit indirekten Beleuchtungslösungen, die zu Ihrem Stil passen, verschönern Sie die Architektur Ihres Raumes und schaffen Atmosphäre. Ob elegant oder organisch, Beleuchtung von oben oder unten, linear oder diffus – mit unserem Sortiment können Sie mit Schatten und Licht spielen, um Ihren Raum größer oder gemütlicher wirken zu lassen.

es —

Mejora la arquitectura de tu habitación y añade ambiente con las soluciones de iluminación indirecta que mejor se adaptan a tu estilo. Podrás disfrutar de todo tipo de luces: elegantes, orgánicas, ascendentes, descendentes, lineales o difusas. Juega con las sombras y la luz para que tu habitación resulte más grande o acogedora.

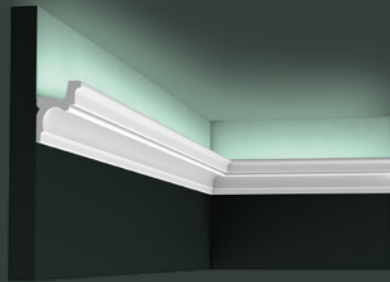

C323
200 x 5,5 x 4,2 cm
Purotouch®

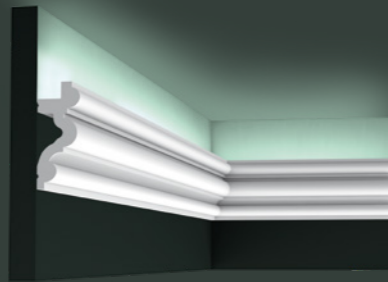

6 C324 AUTOIRE
200 x 8,3 x 3,4 cm
Purotouch®
Designed by
Orio Tonini

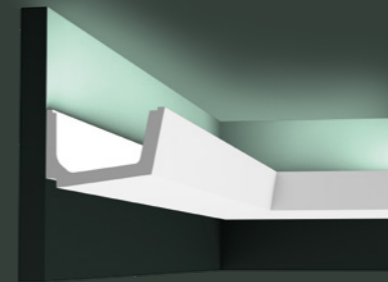
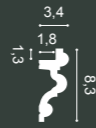

C357 STRAIGHT
200 x 7,1 x 11 cm
Purotouch®
Designed by
Jacques Vergracht

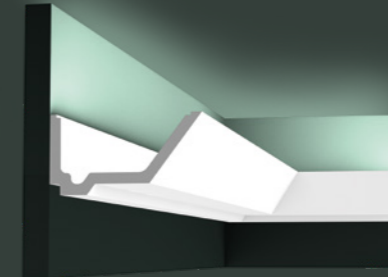
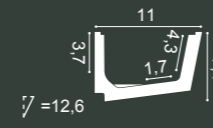

C358 RAIL
200 x 7,3 x 14 cm
Purotouch®
Designed by
Jacques Vergracht

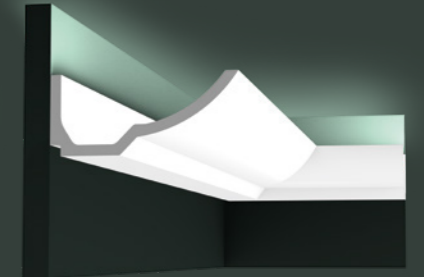
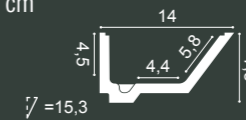

C351 BOAT
200 x 7,4 x 17,3 cm
Purotouch®
Designed by
Jacques Vergracht

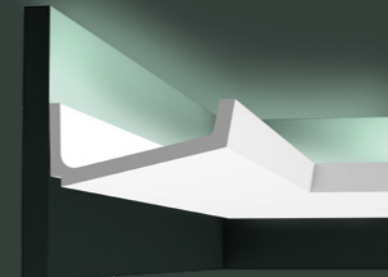
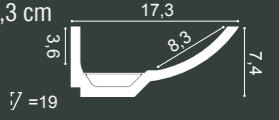

C352 FLAT
200 x 7,6 x 17,1 cm
Purotouch®
Designed by
Jacques Vergracht

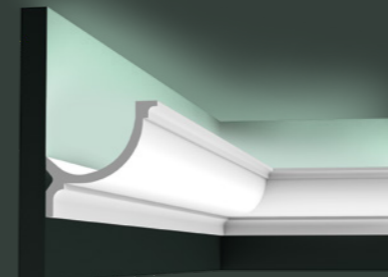
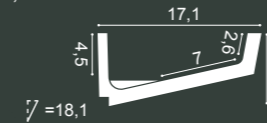

C902 | C902F
200 x 10,3 x 10,3 cm
Purotouch®

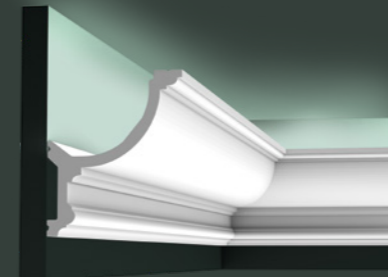
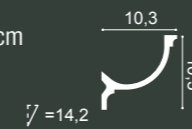

C901 | C901F
200 x 14,8 x 12,4 cm
Purotouch®

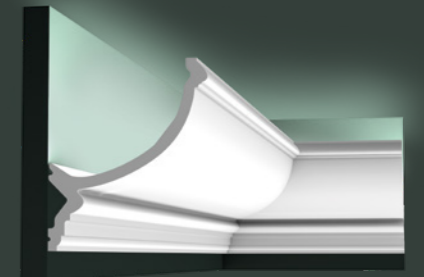
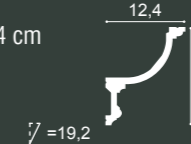

C900
200 x 17,1 x 14,6 cm
Purotouch®



L3 Lighting Combinations

C380

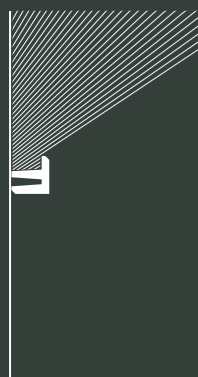

C382 + C380

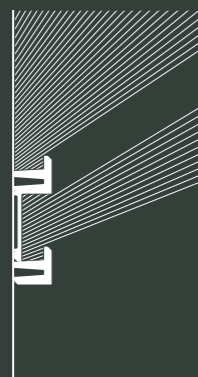

2 C382 + C382 + C380



C382 + C382 + C381

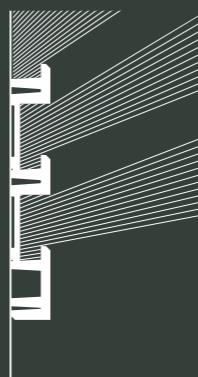

C381

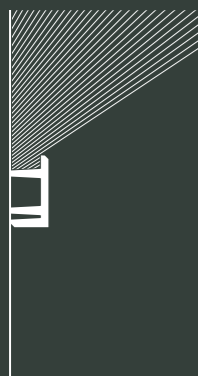

C383 + C381

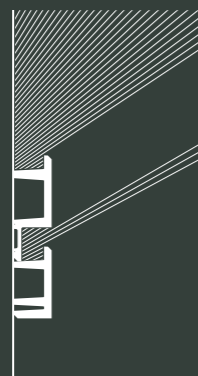

C383 + C383 + C381

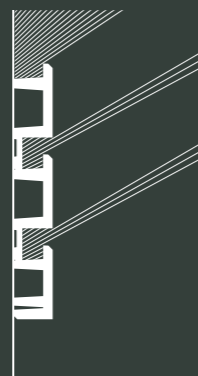

C383 + C382 + C381

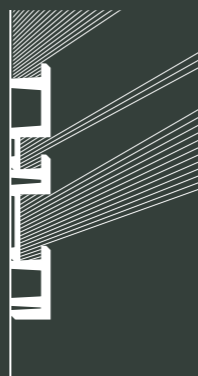

C382 + C383

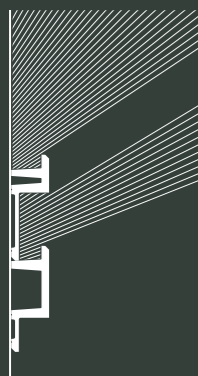

C381 + C382



C382 + C382

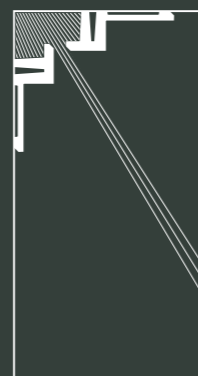

4 C382 + C382 + C382

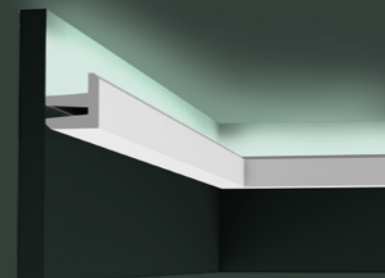
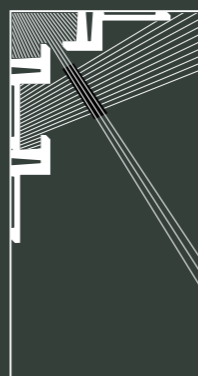

C380 L3 Linear Led Lighting

200 x 5 x 5 cm
Purotouch®

Designed by
Orio Tonini

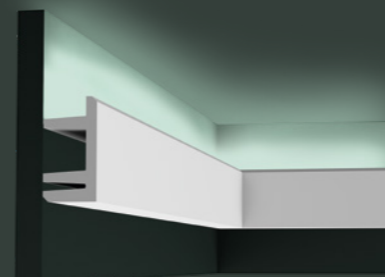
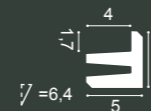

C381 L3 Linear Led Lighting

200 x 9,5 x 5 cm
Purotouch®

Designed by
Orio Tonini

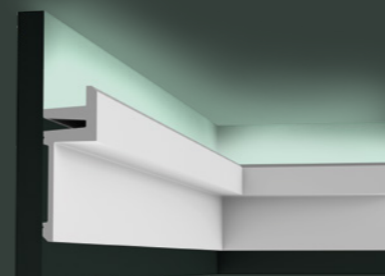
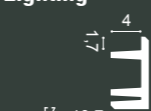

C382 L3 Linear Led Lighting

200 x 14 x 5 cm
Purotouch®

Designed by
Orio Tonini

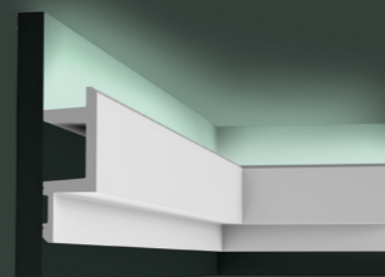

3 C383 L3 Linear Led Lighting

200 x 14 x 5 cm
Purotouch®

Designed by
Orio Tonini



Steps



136

1. C390 p.137

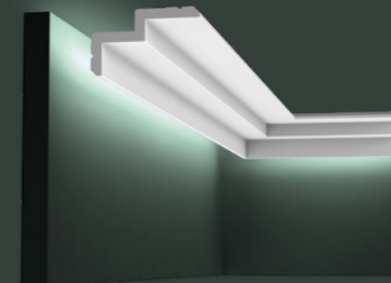

1 C390 STEPS
200 x 6 x 10 cm
Purotouch®
Designed by
Orio Tonini

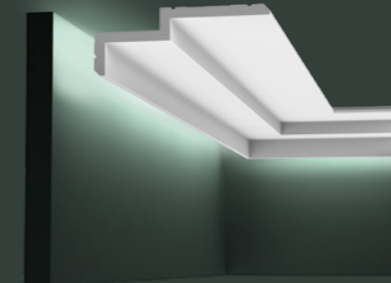
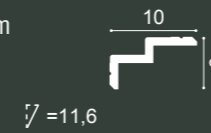

C391 STEPS
200 x 6 x 16 cm
Purotouch®
Designed by
Orio Tonini

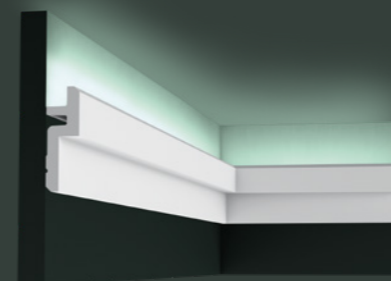
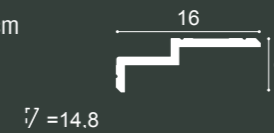

C394 STEPS
200 x 9,5 x 3,1 cm
Purotouch®
Designed by
Orio Tonini

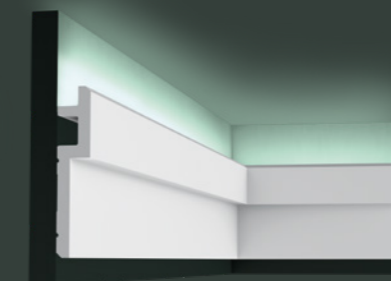
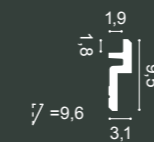

C395 STEPS
200 x 15,5 x 3,1 cm
Purotouch®
Designed by
Orio Tonini

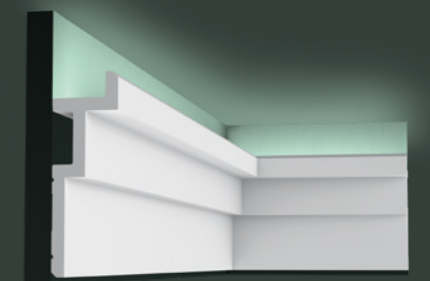
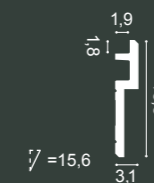

C396 STEPS
200 x 18,5 x 6,1 cm
Purotouch®
Designed by
Orio Tonini

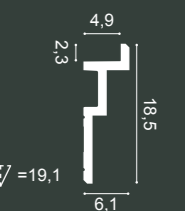

C390

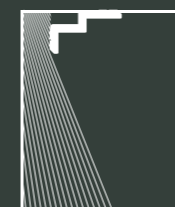

C391

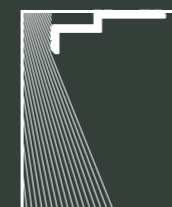

C394

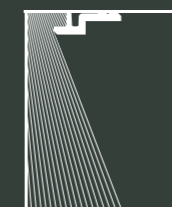

C395

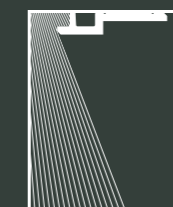

C394

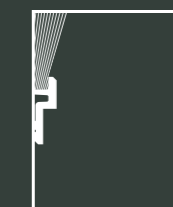

C395

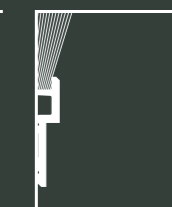

C396

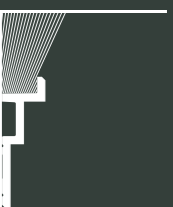

DOWNLIGHTER

UPLIGHTER

137

Led Coveing | Indirecte verlichting | Éclairage indirect | Indirekte Beleuchtung | Iluminación indirecta

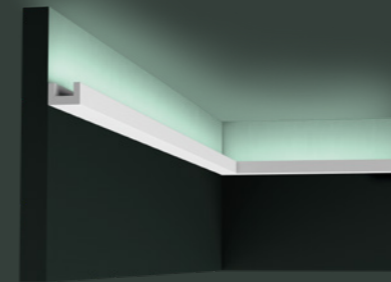

CX190 | CX190F U-PROFILE
200 x 2 x 3 cm
Duropolymer®
Designed by
Orio Tonini

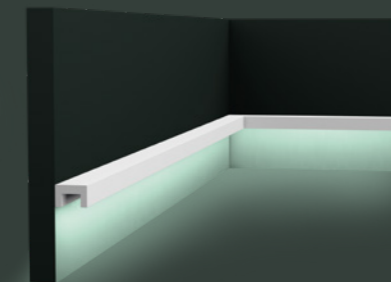

CX190 | CX190F U-PROFILE
200 x 2 x 3 cm
Duropolymer®
Designed by
Orio Tonini

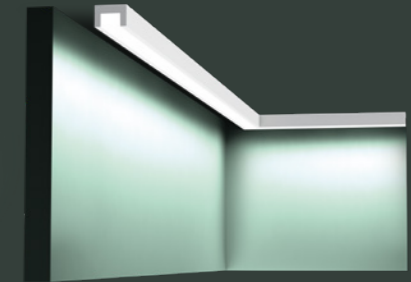

2 CX190 | CX190F U-PROFILE
200 x 2 x 3 cm
Duropolymer®
Designed by
Orio Tonini

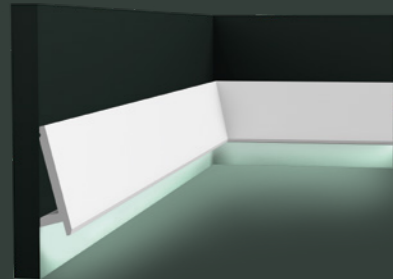

SX179 DIAGONAL
200 x 9,7 x 2,9 cm
Duropolymer®
Designed by
Orio Tonini

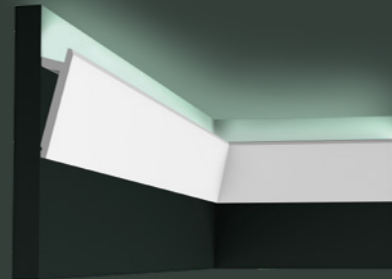
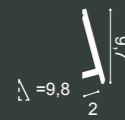

SX179 DIAGONAL
200 x 9,7 x 2,9 cm
Duropolymer®
Designed by
Orio Tonini

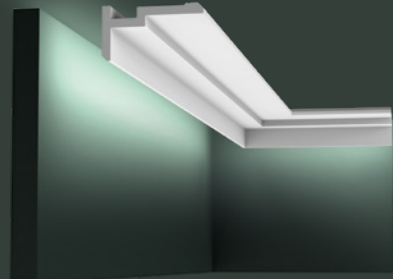
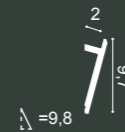

CX197 U-STEPS
200 x 5 x 9,3 cm
Duropolymer®
Designed by
Orio Tonini

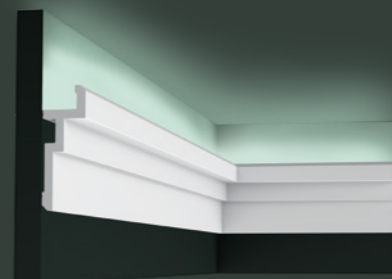

CX196 U-STEPS
200 x 11,3 x 4 cm
Duropolymer®
Designed by
Orio Tonini

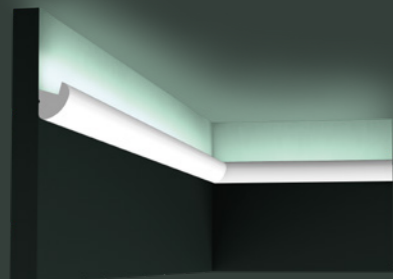

CX188 | CX188F
200 x 3,4 x 3 cm
Duropolymer®
Designed by
Orio Tonini

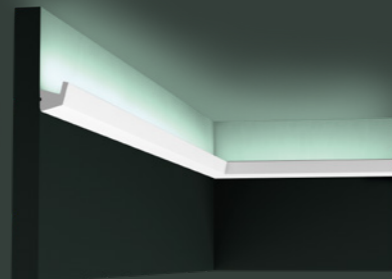

CX189 | CX189F
200 x 2,7 x 2,7 cm
Duropolymer®
Designed by
Orio Tonini



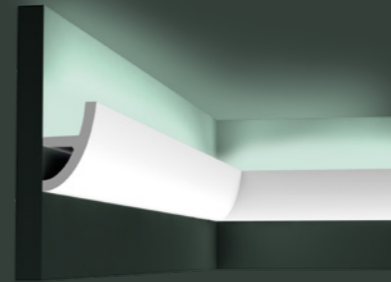

2 C373 | C373F ANTONIO
200 x 8 x 5 cm
Purotouch®
Designed by
Ulf Moritz

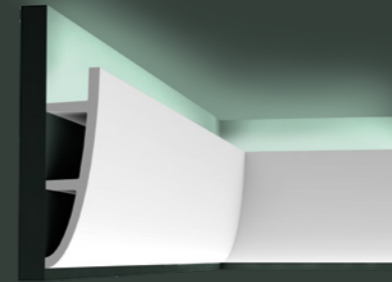
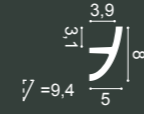

C374 ANTONIO
200 x 18 x 5 cm
Purotouch®
Designed by
Ulf Moritz

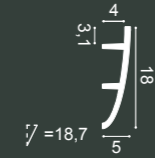

C373 + C374

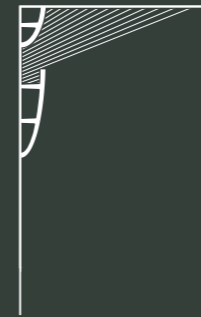

C373 + C373

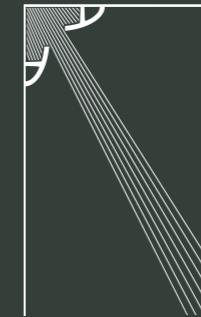

C374 + C991

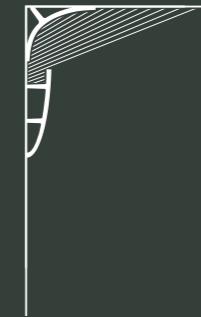

C373 + C373

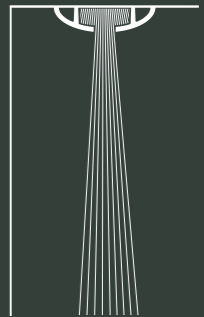

C374 + C374

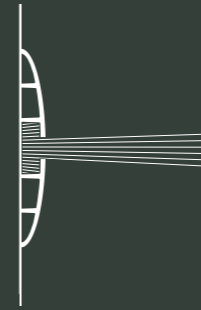

C373 + C374

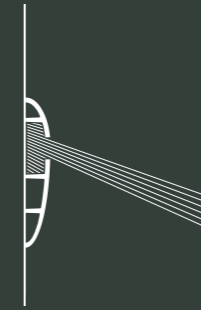

C373 + C373

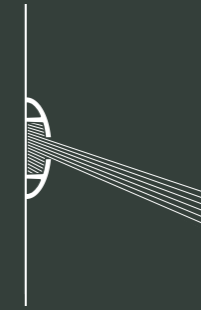

C374 + C373



C373 + C374

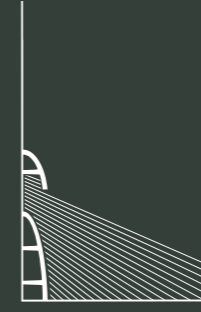

C374 + C374

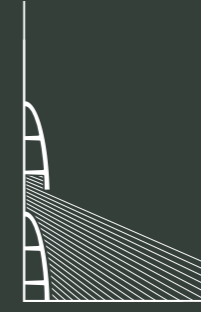

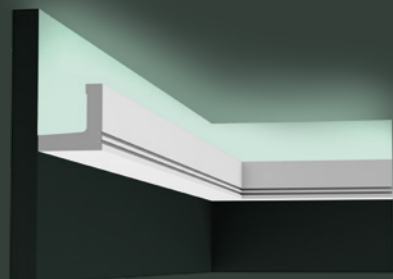

C361 STRIPE
200 x 5 x 5 cm
Purotouch®
Designed by
Pierre Daems

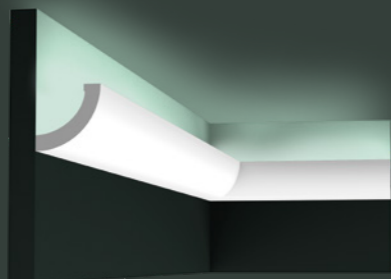
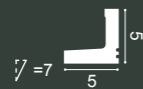

C362 CURVE
200 x 5 x 5 cm
Purotouch®
Designed by
Pierre Daems

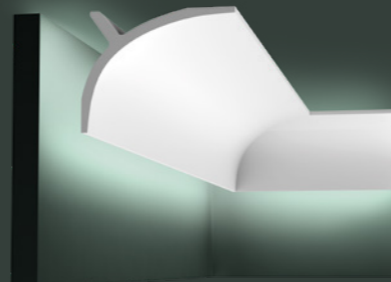
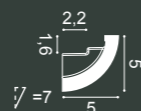

C991
200 x 11 x 14 cm
Purotouch®

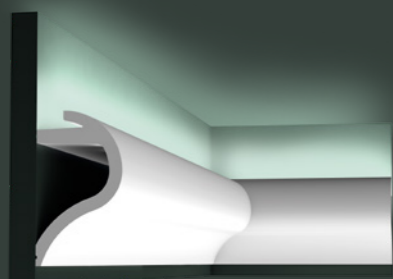
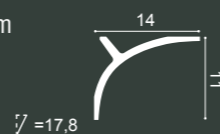

C364 WAVE
200 x 14 x 8 cm
Purotouch®
Designed by
Pierre Daems

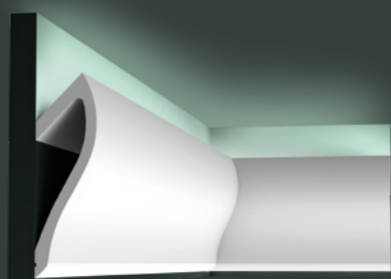
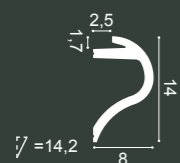

C371 SHADE
200 x 18,5 x 5,8 cm
Purotouch®
Designed by
Ulif Moritz

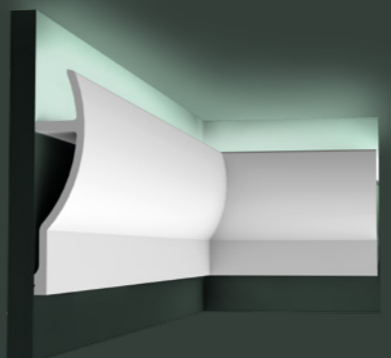
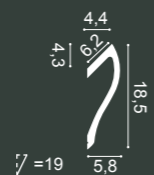

C372 FLUXUS
200 x 28 x 7 cm
Purotouch®
Designed by
Ulif Moritz

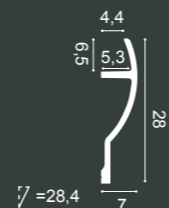

1. SX191 p.95 | 2. P4025 p.106 | 3. C991 p.142 | 4. F30 p.129

Deco Elements

DECORATIEVE ELEMENTEN
ELÉMENTS DÉCORATIFS / ZIERELEMENTE
ELEMENTOS DE DECORACIÓN

144



145



en —

Add a sophisticated final touch to your walls with our deco elements. Ranging from door frames, columns and pilasters to ceiling roses, these elements give your walls elegance, beauty and style that match your vision and budget.

nl —

Leg een verfijnde laatste hand aan je muren met onze decoratieve elementen. Gaande van deurlijstingen, zuilen en pilasters tot rozetten, deze elementen bezorgen je muren elegantie, schoonheid en stijl die past bij je visie en budget.

fr —

Ajoutez une touche finale sophistiquée à vos murs avec nos éléments décoratifs. Des encadrements de porte, colonnes et pilastres aux rosaces de plafond, ces éléments confèrent à vos murs élégance, beauté et style, qui correspondent à votre vision et à votre budget.

de —

Geben Sie Ihren Wänden mit unseren Dekoelementen einen raffinierten letzten Schliff. Von Türrahmen, Säulen und Pilastern bis hin zu Deckenrosetten verleihen diese Elemente Ihren Wänden Eleganz, Schönheit und Stil. Wir haben die Elemente, die Ihren Vorstellungen und Ihrem Budget entsprechen.

es —

Añade un toque final muy sofisticado a tus paredes con nuestros elementos decorativos. Desde marcos de puertas, columnas y pilares hasta rosetones, tenemos para ti todos los elementos que más elegancia, belleza y estilo otorgan a tus paredes y que mejor se adaptan a tu visión y presupuesto.

CEILING ROSES / ROZETTEN / ROSACES / ROSETTEN / ROSETONES



1. R10 p.146 | 2. R31 p.147 | 3. R17 p.147 | 4. R52 p.147



R13 ⊕
ø 28 x 3,1 - ø 2,5 cm
Purotouch[®]



R14 ⊕
ø 33 x 3 - ø 2,5 cm
Purotouch[®]



R31 ⊕
ø 38,5 x 2,7 - ø 3,5 cm
Purotouch[®]



R17 ⊕
ø 47 x 3,5 - ø 6,5 cm
Purotouch[®]



R18
ø 49 x 4,7 - ø 7 cm
Purotouch[®]



R52 ⊕
ø 69,5 x 4,8 - ø 12,5 cm
Purotouch[®]



R73 ⊕
ø 70 x 5,9 - ø 8 cm
Purotouch[®]



R23
ø 71 x 4,4 - ø 6 cm
Purotouch[®]



R27
ø 75 x 4,5 - ø 9 cm
Purotouch[®]



R10 ⊕
ø 15 x 4,2 - ø 2 cm
Purotouch[®]



R11
ø 19 x 3,6 - ø 3 cm
Purotouch[®]



R12
ø 19,5 x 1,8 - ø 1 cm
Purotouch[®]



R22
77,5 x 53 x 3,6 cm
Purotouch[®]



R24
ø 79 x 6 - ø 8 cm
Purotouch[®]



R64 ⊕
ø 95,2 x 4,8 - ø 7 cm
Purotouch[®]



R07
ø 26 x 3 - ø 5 cm
Purotouch[®]



1 R08
ø 38 x 4,2 - ø 5 cm
Purotouch[®]



R09 ⊕
ø 48,5 x 3,7 - ø 6 cm
Purotouch[®]



R66
ø 54,5 / 43 x 2,4 cm
Purotouch[®]



R76
ø 62 x 4,1 - ø 10,5 cm
Purotouch[®]



R77
ø 62 x 4,2 - ø 10,5 cm
Purotouch[®]



R40 ⊕
ø 74,5 x 3,1 - ø 10 cm
Purotouch[®]

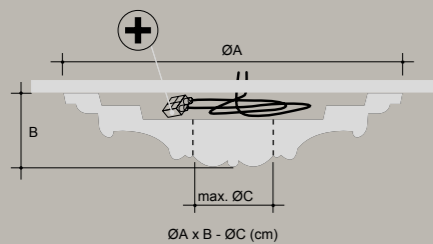

⊕ ROOM FOR CABLES
Holte voor kabels
Place pour les câbles
Hohlraum für Kabel
Espacio para cables



1. R08 p.148

DOOR FRAMES / DEUROMLIJSTINGEN / ENCADREMENTS DE PORTES
TÜRUMRANDUNGEN / MARCOS PARA PUERTAS

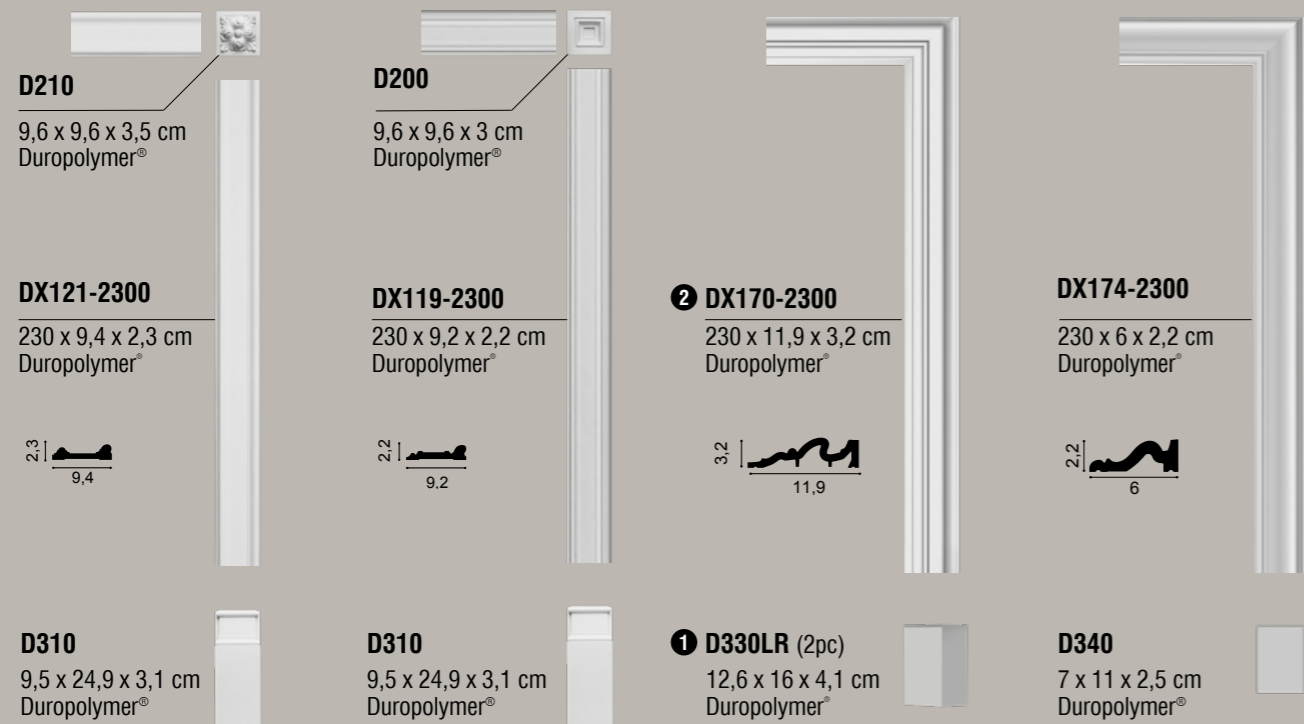

PEDIMENTS / FRONTONS / PEDIMENTE / FRONTALES

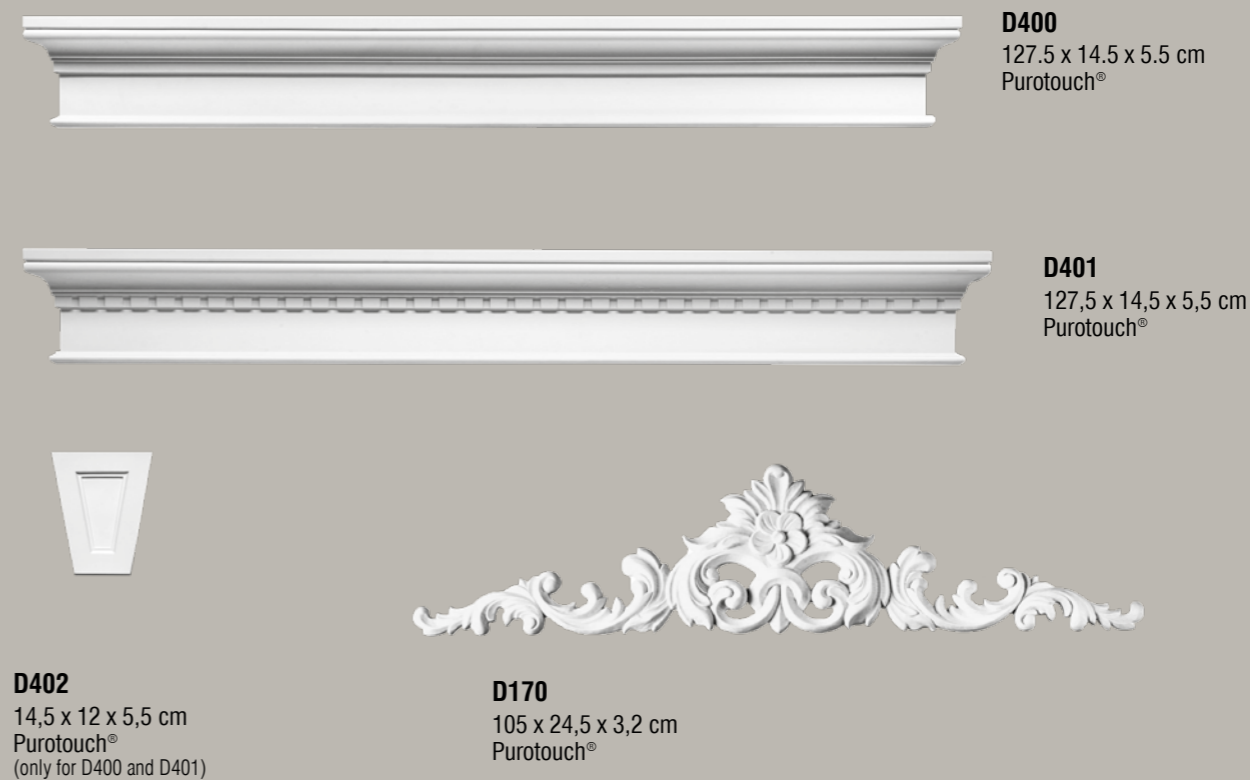

150

151

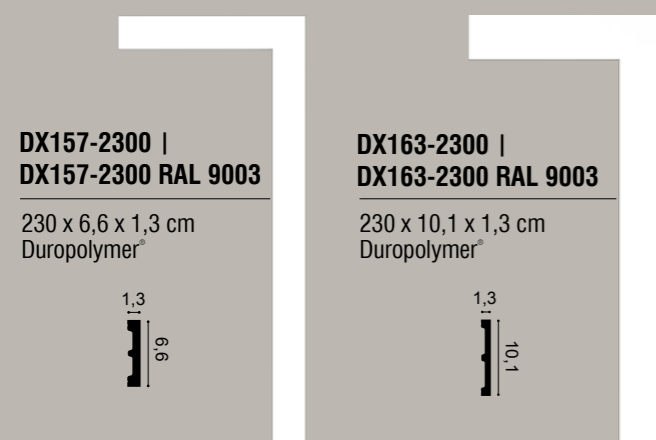

1. D330LR p.150 | 2. DX170-2300 p.150

DOOR PANNELING / DEURPANELEN / PANNEAUX DE PORTES
TÜRPAÑEELE / PANELES PARA PUERTAS



FULL COLUMNS / VOLLE ZUILEN
COLONNES ENTIÈRES / VOLLSÄULEN
COLUMNAS COMPLETAS

HALF COLUMNS / HALVE ZUILEN
DEMI-COLONNES / HALBSÄULEN
MEDIAS COLUMNAS

PILASTERS / PILASTRES / PILASTER / PILASTRAS

K1112
(H 30cm)
Duropolymer[®]



K1122
(H 30cm)
Duropolymer[®]



K1111
(H 30cm)
Duropolymer[®]



K1121
(H 30cm)
Duropolymer[®]

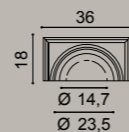

K1002
(H 199,5cm)
Purotouch[®]

Ø 22



K1102
(H 202cm)
Purotouch[®]

Ø 22



K1001
(H 199,5cm)
Purotouch[®]

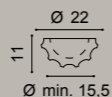

K1101
(H 202cm)
Purotouch[®]

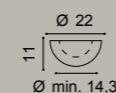

K1152 (H 12,5 cm)
Duropolymer[®]



K1151 (H 12,5 cm)
Duropolymer[®]

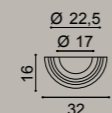

K1132 (H 57,5 cm)
Purotouch[®]



K1131 (H 57,5 cm)
Purotouch[®]

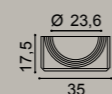

K251 (H 35 cm)
Purotouch[®]

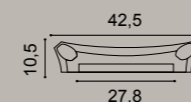

K201 (H 14,9 cm)
Purotouch[®]

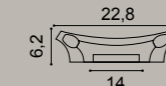

K250 (H 200 cm)
Purotouch[®]

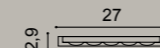

K200 (H 200 cm)
Purotouch[®]

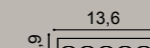

K254 (H 53,5 cm)
Purotouch[®]

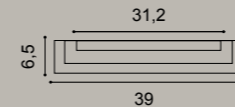

K202 (H 54,1 cm)
Purotouch[®]

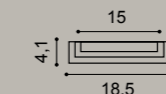

D320 (H 24,8 cm)
Purotouch[®]

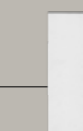
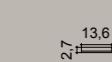

K1112 + K1002 + K1152 = 242 cm H
K1112 + K1002 + K1132 = 287 cm H max
K1122 + K1102 + K1152 = 242 cm H
K1122 + K1102 + K1132 = 287 cm H max

K1111 + K1001 + K1151 = 242 cm H
K1111 + K1001 + K1131 = 287 cm H max
K1121 + K1101 + K1151 = 242 cm H
K1121 + K1101 + K1131 = 287 cm H max



The Perfect Finish

De perfecte afwerking / La finition parfaite
Die Perfekte Installation / El acabado perfecto

Ready? Set? Go!



ONLY FULL WARRANTY WITH DECOFIX
VOLLEDIGE GARANTIE ENKEL BIJ GEBRUIK VAN DECOFIX
GARANTIE TOTALE UNIQUEMENT AVEC COLLE DECOFIX
VOLLSTÄNDIGE GARANTIE NUR BEI DER VERWENDUNG VON DECOFIX
GARANTÍA COMPLETA SÓLO SI SE UTILIZA DECOFIX

Ready? SURFACE & ATMOSPHERE

Omgeving & Ondergrond | Environnement & Surface | Umgebung & Untergrund | Ambiente & Superficie



Storage and installation conditions: Store profiles and adhesives at room temperature and wait 24 hours before installing.

Opslag- en plaatsingsvoorwaarden: Plaats profielen en lijmen 24 uur vóór de installatie op kamertemperatuur.
Conditions d'installation et de stockage: Stockez les profils et les colles à température ambiante 24 heures avant la pose.
Lager- und Installationsbedingungen: Profile und Kleber 24 Stunden vor Verlegung bei Zimmertemperatur lagern.
Condiciones de almacenamiento y de instalación: Colocar molduras y adhesivos en el lugar 24 horas antes de la aplicación.

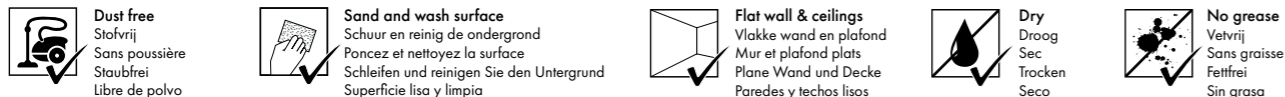

Set? DECOFIX ADHESIVES

DecoFix lijmen | Colles DecoFix | DecoFix Kleber | DecoFix Adhesivos

Interior, porous and dry surface
Binnen, poreuze en droge ondergronden |
Pose à l'intérieur, surfaces poreuses, pièces non humides | Innen, poröse/saugfähige und trockene Untergründe | Interior, superficies porosas y secas



Heavy profile
Zware lijsten
Profils lourds
Schwere Profilen
Perfiles Pesados



Exterior, non-porous and humid surface
Buiten, niet-poreuze en vochtige ondergronden |
Pose à l'extérieur, surfaces non poreuses, environnement humide | Außen, nicht-poröser/saugfähiger Untergrund und Feuchträume | Exterior, superficies no porosas, ambientes húmedos

DecoFix Pro
Strong, water-based acrylic installation adhesive

FDP500 310ml | 7 > 8m
FDP600 4200ml | 65 > 110m

or of ou oder o

DecoFix Power
Very strong MS-Polymer-based installation adhesive

FDP700 290ml | 7 > 8m

DecoFix Extra
Polyurethane-based adhesive

FX200 310ml | min. 80m
FX210 tube 80ml | min. 20m

*** For Durofoam®: use DecoFix Pro for joints**

Voor Durofoam®: gebruik DecoFix Pro voor de naden | Pour Durofoam®: utilisez DecoFix Pro pour les joints | Für Durofoam®: verwenden Sie DecoFix Pro für die Stoßstellen | Para Durofoam®: utilice DecoFix Pro para las uniones entre piezas

DecoFiller
Acrylic filler

FL300 310ml | > 30m

Seal wall/ceiling
Verbinding muur/plafond
Collage mur/plafond
Verbindung Wand/Decke
Adherencia techos/paredes

Joints between mouldings*
Verbinding tussen profielen
Joints entre les profils
Nahtverbindungen zwischen Profilen
Uniones de los perfiles

Filler & finishing
Vullen en afwerking
Enduit et finition
Verfugen und Endbearbeitung
Relleno y acabado

<p>DecoFix Pro FDP500 310ml > 7 - 8m FDP600 4200ml > 65 - 110m</p> <p>Extra strong installation adhesive for porous surfaces and interior applications</p> <ul style="list-style-type: none"> Strong, water-based acrylic glue Long-lasting seal between mouldings and the wall and/or ceiling Remove with humid sponge or cloth Should be kept frost free Paintable after hardening (min. 24 hours) 	<p>DecoFix Power FDP700 290ml > 7 - 8m</p> <p>Extra strong MS polymer glue for new build, all exterior applications, non-porous (tiles, glass, ...) surfaces and damp environments</p> <ul style="list-style-type: none"> Remove with soap solution Paintable after hardening (min. 24 hours) 	<p>DecoFix Extra FX200 310ml > 80m FX210 80ml > 20m</p> <p>Polyurethane-based glue to seam joints between mouldings</p> <ul style="list-style-type: none"> Remove excess glue before hardening (max. 1 hour and repeat after 2-3 hours) Clean with acetone or Synth Thinner Can be painted after 24 hrs The more humidity, the faster the drying time 	<p>DecoFiller FL300 310ml > 30m</p> <p>Ready to use lightweight acrylic filler</p> <ul style="list-style-type: none"> For shrink-proof finishing of gaps (between decorative profiles after adhesion, between wall and profiles, between walls and between wall and ceiling), cracks and irregularities in profiles or on walls Rapidly repairable (after 15 min.) Does not crack
<p>en</p>	<p>nl</p>	<p>fr</p>	<p>es</p>
<p>Extra sterke installatielijm voor poreuze ondergrond en binnentoepassingen</p> <ul style="list-style-type: none"> Sterke acrylijm op waterbasis Langdurende verbinding tussen profielen en muur en/of plafond Verwijder met een vochtige spons of doek Vorstvrij bewaren Overschilderbaar na uitharding (min. 24u) 	<p>Extra sterke MS-polymeerlijm voor nieuwbouw, buitengebruik, op niet-poreuze (tegels, glas,...) ondergrond en in vochtige ruimtes</p> <ul style="list-style-type: none"> Verwijder met een zeepoplossing Overschilderbaar na uitharding (min. 24u) 	<p>Lijm op polyurethaanbasis voor naadverbindingen tussen profielen</p> <ul style="list-style-type: none"> Verwijder de overtollige lijm vóór uitharding (herhaal na max. 1 uur en na 2 tot 3 uur) Maak schoon met aceton of synthetische verdunner Overschilderbaar na 24 uur Hoe hoger de vochtigheidsgraad, hoe sneller de droogtijd 	<p>Kant-en-klare lichte vulpasta op acrylbasis</p> <ul style="list-style-type: none"> Voor krimprij afwerken van naden (tussen sierprofielen na lijmen, tussen wand en profiel, tussen wanden onderling en tussen wand en plafond), scheuren en oneffenheden in profielen of binnenmuren Snel overschilderbaar (na 15min.) Kraakt niet
<p>Colle d'installation ultra forte pour surfaces poreuses et applications intérieures</p> <ul style="list-style-type: none"> Colle forte à base d'eau et d'acrylique Joint longue durée entre les moulures et le mur et/ou le plafond Retirez à l'aide d'une éponge ou d'un chiffon humide Doit être conservé à l'abri du gel Peut être peinte après séchage (min. 24 heures) 	<p>Colle au MS polymère extra forte pour constructions nouvelles, utilisation extérieure, surfaces non poreuses (carrelage, verre, etc...) et environnements humides</p> <ul style="list-style-type: none"> Enlevez à l'aide d'une solution savonneuse Peut être peinte après séchage (min. 24 heures) 	<p>Colle polyuréthane pour l'assemblage des joints entre les moulures</p> <ul style="list-style-type: none"> Éliminez les excès de colle avant le durcissement (1 heure max. et recommencez après 2-3 heures) Nettoyez avec de l'acétone ou un diluant synthétique Peut être peint après 24 h Un taux d'humidité plus élevé peut accélérer le temps de séchage 	<p>Enduit léger prêt à l'emploi à base d'acrylique</p> <ul style="list-style-type: none"> Pour une finition irrétrécissable de joints (entre profils décoratifs après adhésion, entre murs et profils, entre mur et plafond et murs entre eux), fissures, trous et irrégularités dans les profils ou les murs Peut être recouvert rapidement (après 15 min.) Ne se fissure pas
<p>de</p>	<p>es</p>	<p>fr</p>	<p>es</p>
<p>Extra starker Montagekleber auf saugenden Untergründen und für den Innenbereich</p> <ul style="list-style-type: none"> Starker, wasserbasierter Acrylkleber Langhaltende Verbindung zwischen Profilen und Wand und/oder Decke Mit leicht feuchtem Schwamm oder Tuch entfernen Frostfrei lagern Anstrichverträglich nach Aushärtung (min. 24 St.) 	<p>Besonders starker MS-Polymerkleber für Neubauten, den Außenbereich, auf nicht porösem (Fliesen, Glas, ...) Untergrund und in Feuchträumen</p> <ul style="list-style-type: none"> Mit Seifenlösung entfernen Anstrichverträglich nach Aushärtung (min. 24 St.) 	<p>Polyurethanbasierter Kleber für die Nahtverbindungen zwischen Profilen</p> <ul style="list-style-type: none"> Überschüssigen Kleber vor dem Aushärten entfernen (nach 1 Std und nach 2-3 Std wiederholen) Mit Aceton oder synthetischem Verdünner reinigen Nach 24 Std überstreichbar Je höher die Luftfeuchtigkeit, desto kürzer die Trockenzeit 	<p>Gebrauchsfertige Lichtspachtelpaste auf Acrylbasis</p> <ul style="list-style-type: none"> Zur schrumpffreien Endbearbeitung von Fugen zwischen Dekoprofilen nach der Montage. Kann ebenfalls für das Verfüllen der Fugen bzw. Lücken zwischen dem Profil und dem Untergrund auf dem es montiert wurde verwendet werden. Beschädigungen an Wand oder Profil können mit der Füllstoff ausgeglichen werden. Schnell überstreichbar (nach 15 min.) Reißt nicht
<p>Adhesivo superfuerte para soportes porosos y aplicaciones en el interior</p> <ul style="list-style-type: none"> Fuerte, cola acrílica con base de agua Larga adherencia entre molduras y techos o paredes Eliminar con una esponja o paño húmedo Debe guardarse en un ambiente seco Paintable después de endurecimiento (mín. 24 horas) 	<p>Adhesivo MS polímero extra fuerte para construcciones nuevas, aplicaciones de exterior, superficies no porosas (cerámica, vidrio, ...) y lugares húmedos</p> <ul style="list-style-type: none"> Eliminar con agua y jabón Paintable después de endurecimiento (mín. 24 horas) 	<p>Adhesivo a base de poliuretano para unir las piezas entre si</p> <ul style="list-style-type: none"> Eliminar cola excesiva antes de endurecer (máx. 1 hora y repetir 2-3 horas después) Limpia con acetona o disolvente sintético en las instalaciones Puede pintarse después de 24 horas Cuánta más humedad, más rápido el secado 	<p>Masilla ligero lista para usar en base acrílica</p> <ul style="list-style-type: none"> Especial para un buen acabado final de juntas, indicada también para transiciones los perfiles con las paredes y/o techos. Ideal para sellar pequeñas grietas e irregularidades que nos podemos encontrar en las instalaciones Se puede pintar rápidamente, pasados 15 min. de su aplicación No merma, ni fisura

TOOLS | Toebehoren | Accessoires | Zubehör | Accesorios

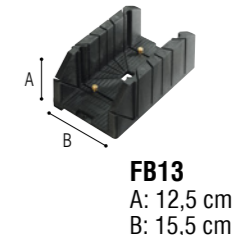
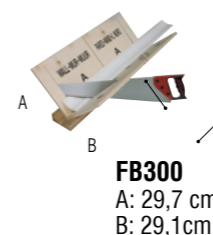

Go! INSTALLATION VIDEOS & MANUALS

DECOFIX GLUE CALCULATOR



SCAN THE QR CODE
OR VISIT
WWW.ORACDECOR.COM > INSTALLATION

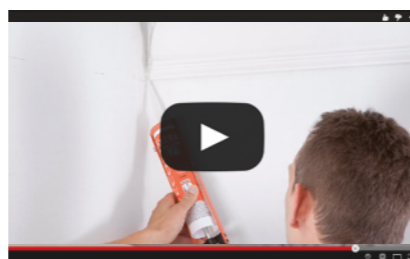

Flexible Products

Flex Radius	R min in cm	R* min in cm	R**min in cm	Flex Radius	R min in cm	R* min in cm	R**min in cm	Flex Radius	R min in cm	R* min in cm	R**min in cm
C211F	250			DX174F	60	300		SX173F	45		
C213F	280			P3020F	50	180		SX180F	45		
C215F	160			P4020F	40	200		SX182F	35	100	
C217F	380			P4025F	70			SX183F	40		
C220F	400			P5021F	20	70		SX184F	45		
C230F	150			P7070F	30	230		SX187F	40		
C240F	270			P8020F	40	130		SX194F	25	80	
C250F	70			P8030F	20	70		SX195F	30		
C304F	250			P8040F	30			W108F	30		40
C321F	140			P8050F	80	200		W109F	30		40
C325F	300			P9010F	40	310		W110F	30		40
C326F	500			P9050F	20	60		W111F	30		40
C331F	420			P9900F	20	250		W114F	30		40
C333F	300			PX103F	20	80		W116F	30		40
C334F	380			PX120F	30	110		W119F	30		40
C339F	380			PX144F	20	220					
C341F	400			PX175F	30	80					
C373F	100			PX198F	70						
C901F	600			PX201F	30	80					
C902F	600			PX202F	60	150					
CX100F	200			PX209F	20	70					
CX106F	360			SX104F	40						
CX109F	160			SX105F	30						
CX110F	180			SX118F	40						
CX123F	280			SX137F	40						
CX124F	160			SX138F	40						
CX127F	240			SX155F	30						
CX132F	70			SX157F	35	260					
CX188F	110			SX162F	20	80					
CX189F	90			SX163F	35						
CX190F	30	130		SX165F	40						
CX199F	200			SX172F	35						

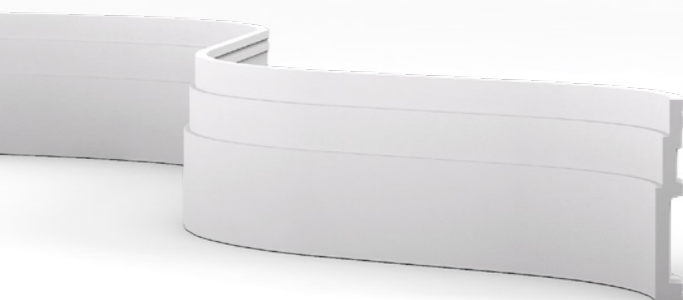
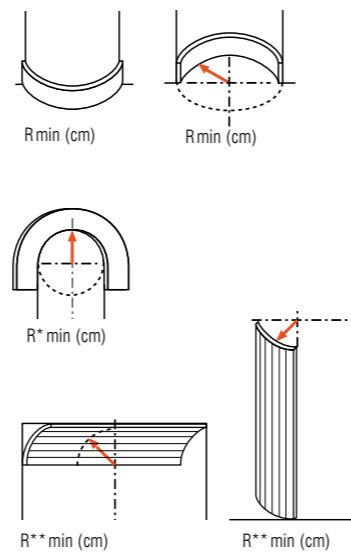

en —

A wide range of cornice mouldings, panel mouldings and skirting boards are available in a flexible variant to give curved walls and ceilings an elegant finish. These elements are also light and can be painted.

The sky is the limit: add curved lines and circles to your walls and ceilings in no time.

nl —

Een groot aantal kroonlijsten, wandlijsten en plinten zijn verkrijgbaar in een flexibele variant. Ook gebogen wanden en plafonds kunnen zo elegant worden afgewerkt. Ze zijn bovendien ook licht en overschilderbaar!

Je kan het zo gek niet bedenken: gebogen lijnen en cirkels zet je zonder enige moeite op muur en plafond.

fr —

De nombreuses corniches, cimaises et plinthes sont disponibles dans des modèles variés. Les murs et plafonds courbes peuvent également bénéficier d'une finition élégante. En outre, ils sont clairs et peuvent être peints!

Vous n'auriez jamais imaginé qu'il serait aussi facile d'installer des lignes courbes et des cercles au mur et au plafond.

de —

Sehr viele Fries-, Wand- und Sockelleisten sind in biegebarer Ausführung erhältlich. Auch geschwungene Wände und Decken lassen sich so elegant verschönern. Zudem sind sie leicht und können überstrichen werden!

Unvorstellbar! Auch geschwungene Linien und Kreise lassen sich problemlos an Wänden und Decken anbringen.

es —

Hay disponibles variantes flexibles para una gran variedad de cornisas, molduras y zócalos. Así puedes dar un elegante acabado a las paredes y los techos arqueados. ¡Además, son ligeros y están listos para pintar!

Todo lo que puedas imaginar: coloca líneas arqueadas y círculos sin problema en la pared y el techo.

Index

C

C200	67
C201	71
C211 C211F	70
C212	71
C213 C213F	67
C215 C215F	67
C216	67
C217 C217F	67
C219	71
C220 C220F	67
C230 C230F	67
C240 C240F	74
C250 C250F	74
C260	74
C301	67
C303	71
C304 C304F	71
C305	70
C305 + C211	70
C305 + C213	70
C307	70
C307 + C307A	70
C308	71
C321 C321F	72
C322	67
C323	132
C324	132
C325 C325F	65
C326 C326F	65
C327	65
C331 C331F	68
C332	72
C333 C333F	68
C334 C334F	68
C335	68
C336	66
C338	66
C338A	66
C338B	66
C339 C339F	72
C340	72, 81
C341 C341F	64, 81
C342	64, 81
C343	64, 81
C344	64
C351	133
C352	133
C353	78
C354	78
C355	78
C356	78

C357	133
C358	133
C360	78
C361	142
C362	142
C364	142
C371	142
C372	142
C373 C373F	141
C374	141
C380	135
C381	135
C382	135
C383	135
C390	77, 81, 137
C391	77, 81, 137
C392	77
C393	77
C394	77, 81, 137
C395	77, 81, 137
C396	77, 81, 137
C400	78
C422	70
C602	78
C900	68, 133
C901 C901F	68, 133
C902	133
C902 C902F	68
C990	75
C990 + 2x P9900	75
C990 + P9900	75
C991	74, 81, 142
C991 + 2x P9900	74
C991 + P9900	74
CB500	87
CB501	87
CB502	87
CB503	87
CB510	87
CB511	87
CB512	87
CB520	87
CB521	87
CB522	87
CB523	87
CB524	87
CB525	87
CB530	87
CB531	87
CX100 CX100F	82
CX101	83
CX106 CX106F	82
CX107	83
CX108	83

CX109 CX109F	84
CX110 CX110F	83
CX111	83
CX112	83
CX115	84
CX123 CX123F	82
CX124 CX124F	82
CX126	84
CX127 CX127F	82
CX128	83
CX129	83
CX132 CX132F	84, 98
CX133	84, 98
CX134	113
CX141	84
CX148	84
CX154	83
CX160	86
CX161	86
CX176	84
CX177	83
CX188 CX188F	138
CX189 CX189F	138
CX190 CX190F	85, 98, 102, 112, 139
CX192	84
CX196	81, 85, 138
CX197	81, 85, 112, 138
CX199 CX199F	82
CX203	82

D

D170	151
D200	150
D210	150
D310	150
D320	153
D330LR	150
D340	150
D400	151
D401	151
D402	151
D503	151
D504	151
D506	151
D507	151
DX119-2300	110, 150
DX121-2300	110, 150
DX157-2300	150
DX163-2300	150
DX170-2300	110, 150
DX174-2300	150
DX174-2300 DX174F	110

F

F30	129
-----	-----

K

K200	153
K201	153
K202	153
K250	153
K251	153
K254	153
K1001	152
K1002	152
K1101	152
K1102	152
K1111	152
K1112	152
K1121	152
K1122	152
K1131	152
K1132	152
K1151	152
K1152	152

P

P20	115
P101A	115
P801C	115
P1020	107
P3020A	115
P3020 P3020F	107
P3070	108
P3071	108
P4020A	115
P4020 P4020F	106
P4025 P4025F	106
P5020	108
P5020B	115
P5021 P5021F	108
P6020	107
P7020	107
P7030	107
P7070 P7070F	108
P8020 P8020F	106
P8030C	115
P8030D	115
P8030 P8030F	106
P8040 P8040F	106
P8050 P8050F	106
P8060	108
P9010 P9010F	106
P9020	106
P9040	106
P9050 P9050F	108
P9900 P9900F	108
P9901	108
PB513	87

PX102	111
PX103 PX103F	111
PX103A	115
PX113	111
PX116	111
PX117	111
PX120 PX120F	111
PX120A	115
PX144 PX144F	111
PX147	112
PX164	86
PX169	112
PX175 PX175F	111
PX198 PX198F	85, 98, 102, 112
PX201 PX201F	111
PX202 PX202F	111
PX209 PX209F	113

R

R07	148
R08	148
R09	148
R10	146
R11	146
R12	146
R13	147
R14	147
R17	147
R18	147
R22	147
R23	147
R24	147
R27	147
R31	147
R40	148
R52	147
R64	147
R66	148
R73	147
R76	148
R77	148

S

SX104 SX104F	95
SX105 SX105F	96
SX118 SX118F	93
SX122	94
SX125	99
SX137 SX137F	94
SX138 SX138F	94
SX155 SX155F	96
SX156	95
SX157 SX157F	86, 93, 102, 113
SX159	99, 103, 111
SX162 SX162F	86, 93, 102, 113
SX163 SX163F	86, 93, 103, 113
SX165 SX165F	93

SX168	103, 113
SX171	93, 101
SX172 SX172F	99
SX173 SX173F	93
SX179	99, 138
SX180 SX180F	97, 102
SX181	97, 102
SX182 SX182F	86, 93, 103
SX182 SX182F	113
SX183 SX183F	86, 93, 103, 113
SX184 SX184F	86, 93, 103
SX185	93, 101
SX186	93, 101
SX187 SX187F	97, 102
SX191	95
SX193	94
SX194 SX194F	85, 98, 102, 113
SX195 SX195F	96
SX206	94
SX207	103, 120

W

W100	128
W101	128
W102	128
W103	128
W105	128
W106	128
W107	128
W108 W108F	118
W109 W109F	119
W110 W110F	118
W111 W111F	121
W112	123
W113	123
W114 W114F	119
W116 W116F	121
W117	122
W119 W119F	121
W120	126
W121	126
W122	126
W123	126
W130	123
W212	119
WX204	120
WX204-2600	120
WX205	120
WX205-2600	120

CONCEPT

WeWantMore
Gazeuse.be

GRAPHICS

Gazeuse.be

SPECIAL THANKS TO

Sur Mesure Interieur	www.surmesure-interieur.be	4, 27, 44-45, 107
dejaegerinterieurarchitecten	www.dejaegerinterieurarchitecten.be	4-5, 18, 28-29
Marie-Emilie Geerinckx	www.marieemiliegeerinckx.be	5, 18, 136
Ligne Pure	www.lignepure.com	8
Heerenhuis Manufactuur	www.heerenhuis.be	8,12-13
Ethnicraft	www.ethnicraft.com	8, 96
Authentic and so	www.authenticandso.com	12-13
PR Living	www.prliving.com	14-15
Limited Edition	www.le.be	14-15
Taps & Baths	www.badwinkel.be	19
The Hoxton Paris	www.thehoxton.com/paris	19
Ton sur Ton	www.tonsurton.be	19, 50-51, 125
Simon De Backere	www.simondebackere.be	19, 50-51, 125
Joana Sultan_Agence Gabeli	www.agence-gabeli.fr	20,26,40,46
Atelier DAAA	www.atelierdaaa.com	24-25
Romain Ricard	www.romainricard.com	24-25
Adriana Nicolau	www.adriananicolau.es	32-33
CASA DECOR Madrid	www.casadecor.es	37, 69, 79, 85, 114, 129, 143
Dica	www.dica.es	37, 69
Frederiek Van Pamel	www.frederiekvanpamel.be	38-39
WeWantMore	https://wewantmore.studio/	47
Boulangerie Henri	www.boulangerie-henri.be	52-53
Hotel Astoria	www.hotelastoria.be	54-55
Crevits Decoraties	www.crevits-decoraties.be	54-55
Danny Hoorelbeke	www.projectvif.be	54-55
Pillows Grand Boutique Hotel Reylof	www.pillowshotels.com/ghent	56-57
Rietveld Projects	www.rietveldprojects.be	60, 97
Balo	www.balo.be	71, 92
Restaurant Du Progrès	www.duprogres.be	77
Ele Room 62	https://eleroom62.com/	79
Virginia Sánchez Interiorismo	www.virginiasanchezinteriorismo.com	85
Groep Versluys	www.groepversluys.be	100
Alexandra Chigintseva, Igor Gulyaev	www.chigintseva.ru	103
Virginia Gasch	http://vgliving.com/	114
Ekaterina Pozdnyakova	www.pozdnyakovadesign.ru	128
Marisa Gallo	https://interiorisimo.com/	129
Bontemps-Les Espaces;		
Soledad Ordóñez Giordano	www.bontemps.es	143
De Huiskamer	www.dehuiskamer.be	146
Syngedaaw Nicolas	info@nsdeco.be	146
Paloma Pacheco Turnes	www.palomapachecoturnes.com	32-33
Bert Demasure	www.bertdemasure.com	34-35,80,150
Studio IDA	www.studioidaarchitecture.com	21
Denys Vinson	www.denysvinson.com	21
Cafeine	www.cafeine.be	
Frederik Vercruyse	www.frederikvercruyse.com	47
Verne	www.verne.be	
& Jill, Brecht-Alexander, Laura, Leon en Heloise		

REGISTERED CTM DESIGN N°

C323/006632071-0001	C364/1890526-0004	CB512/1890526-0007	P8060/1810706-0002	SX195/008175871-0003
C324/006632071-0002	C370/2088880-0001	CB523/1035273-0002	P9900/000995576-0004	W100/003356278-0001
C325/006632071-0003	C371/2088880-0002	CB530/1890526-0008	P9901/000995576-0005	W101/003356278-0002
C326/006632071-0004	C372/2088880-0003	CB531/1890526-0009	PB513/1890526-0006	W102/003356278-0003
C327/006632071-0005	C373/002524769-0005	CX176/003242569-0009	PX147/002341727-0003	W103/003356278-0004
C335/000995576-0001	C374/002524769-0006	CX177/003242569-0010	PX169/002341727-0002	W105/004097780-0001
C336/1035273-0001	C380/003242569-0001	CX188/005329026-0004	PX175/003242569-0012	W106/005329026-0008
C338/1978214-0001	C381/003242569-0002	CX189/005329026-0005	PX198 008873806-0003	W107/005329026-0009
C338A/002341727-0007	C382/003242569-0003	CX190/005329026-0006	PX201 008873806-0005	W108/005329026-0010
C338B/002341727-0006	C383/003242569-0004	CX192/006632071-0006	PX202 008873806-0006	W109/006379848-0001
C339/1978214-0002	C390/003242569-0005	CX196 008873806-0001	R70/2088880-0006	W110/006379848-0002
C340/1978214-0003	C391/003242569-0006	CX197 008873806-0002	SX156/000995576-0006	W111/008175871-0004
C341/002524769-0001	C392/003242569-0007	CX199 008873806-0004	SX165/002341727-0001	W112/008175871-0005
C342/002524769-0002	C393/003242569-0008	CX203 008873806-0007	SX171/002920140-0001	W113/008175871-0006
C343/002524769-0003	C394/005329026-0001	DX168-2300/002341727-0004	SX172/003242569-0013	W114 008711071-0001
C344/002524769-0004	C395/005329026-0002	DX170/002524769-0008	SX173/003242569-0014	W116 008711071-0002
C351/000257464-0003	C396/005329026-0003	DX174-2300/003242569-0011	SX179/003242569-0015	W120/006632071-0009
C352/000257464-0004	C990/000995576-0002	DX182/004097780-0002	SX180/003242569-0016	W121/006632071-0010
C353/000257464-0005	C991/002524769-0007	DX183/004097780-0003	SX181/003242569-0017	W122/006632071-0011
C354/000257464-0006	CB500/1035273-0006	DX184/004097780-0004	SX185/004097780-0005	W123/006632071-0012
C355/000257464-0007	CB501/1035273-0005	P3020A/002341727-0005	SX186/004097780-0006	W130/006987111-0001
C356/000257464-0008	CB502/1035273-0007	P3070/2088880-0004	SX187/005329026-0007	
C361/1890526-0001	CB503/1890526-0005	P3071/2088880-0005	SX191/006632071-0008	
C362/1890526-0002	CB510/1035273-0004	P4025/006632071-0007	SX193/008175871-0001	
C363/1890526-0003	CB511/1035273-0003	P8050/000995576-0003	SX194/008175871-0002	

Guarantee terms and conditions apply if provided installation instructions have been followed to the letter. Fire retardant standards. In many interiors and projects strict fire regulations are imposed. Therefore, ORAC has implemented a number of solutions depending on the country and its regulations. Please contact us for more information. The information in this catalogue is without engagement. Changes and discrepancies in sizes or/and shapes against those stated in the catalogue can occur. This catalogue and the design embodied within are protected by copyright law and international treaties. Unauthorized reproduction of the catalogue, any portion of it or the reproduction of the designs embodied therein may result in severe civil and criminal penalties and will be prosecuted to the maximum. Further legal information can be found on: www.oracdecor.com/nl/disclaimer.



This catalogue is printed
on FSC-certified paper.

ORAC HEADQUARTERS

NV ORAC SA
Biekorfstraat 32
8400 Ostend, Belgium
T +32 59 80 32 52
info@oracdecor.com

ORAC BENELUX

Biekorfstraat 32
8400 Ostend, Belgium
NL: T +31 852 08 40 59
BeLux: T +32 59 79 02 82
benelux@oracdecor.com

ORAC DEUTSCHLAND

Boltensternstraße 159A
50735 Köln, Germany
T +49 221 747 499 39
deutschland@oracdecor.com

ORAC AUSTRIA

T +43 662 23 49 27
oesterreich@oracdecor.com

ORAC FRANCE

13 Rue Séguier
75006 Paris, France
T +33 188803631
france@oracdecor.com

ORAC EXPORT

T +32 59 79 02 83
export@oracdecor.com

ORAC SLOVAKIA S.R.O.

Kpt. Nalepku 6
08271 Lipany - SK
T +421 232 784 952
slovakia@oracdecor.com

ORAC SPAIN

C/ Roger de Llúria 67-69 Pral 2^a
08009 Barcelona - ES
T +34 938 56 49 00
spain@oracdecor.com

ORAC (UK) LTD

Office: Unit 8, City Bus. Ctr.
6 Brighton Rd, Horsham RH13 5BB - UK
Showroom: Casala, 2 Sycamore St
London, EC1Y 0SF - UK
T +44 1403 240 102
uk@oracdecor.com

ORAC IRELAND

T +35 381 8000 280
ireland@oracdecor.com

ORAC ITALIA SRL

Corso Giacomo Matteotti, 5/H
23900 Lecco (LC), Italy
T +39 0341 362062
italia@oracdecor.com

ORAC RUSSIA

249020, Россия, Калужская область,
Боровский район, Индустриальный парк Ворсино,
3-ий восточный проезд, строение 4
ООО «Орак»
T +7 495 799 70 60
info@oracdecor.ru